

# *Installation Manual*

## *NavNet TZtouchXL*

### *Model TZTBBX*

---

<b>SAFETY INSTRUCTIONS .....</b>	<b>i</b>
<b>SYSTEM CONFIGURATION .....</b>	<b>iii</b>
<b>EQUIPMENT LISTS.....</b>	<b>v</b>
<b>1. MOUNTING.....</b>	<b>1</b>
1.1 Mounting Considerations .....	1
1.2 Security Risk Considerations .....	1
1.3 How to Install the Processor Unit.....	2
<b>2. WIRING.....</b>	<b>3</b>
2.1 Precautions for Tabletop Mounting .....	3
2.2 Interface Connections (rear of the unit) .....	3
2.3 Power Cable .....	5
2.4 MULTI Cable.....	5
2.5 DRS Radar Sensor Connections .....	6
2.6 Network Connection with Other TZT Series Units .....	6
2.7 NMEA 2000 Connector .....	7
2.8 Example TZTBBX System Configuration.....	13
2.9 SUZUKI Outboard Motor Connection .....	14
<b>3. HOW TO SET UP THE EQUIPMENT .....</b>	<b>15</b>
3.1 How to Manage Device Communication.....	17
3.2 How to Set Time Zone, Time Format and Language.....	18
3.3 How to Set Units of Measurement .....	19
3.4 Initial Setup .....	20
3.5 How to Set Up the Radar (For the service technician only).....	28
3.6 How to Set Up the Fish Finder .....	32
3.7 Wireless LAN Setting .....	38
3.8 Ferry Mode.....	39
3.9 How to Manage Your Charts.....	39
3.10 IP Camera Setup .....	44
3.11 How to Set Up the SUZUKI Engine .....	45
<b>APPX. 1 JIS CABLE GUIDE .....</b>	<b>AP-1</b>
<b>PACKING LIST(S) .....</b>	<b>A-1</b>
<b>OUTLINE DRAWING(S) .....</b>	<b>D-1</b>
<b>INTERCONNECTION DIAGRAM(S) .....</b>	<b>S-1</b>



# SAFETY INSTRUCTIONS



## WARNING

Indicates a potentially hazardous situation which, if not avoided, could result in death or serious injury.



## CAUTION

Indicates a potentially hazardous situation which, if not avoided, may result in minor or moderate injury.

(Examples of symbols)



Warning, Caution



Prohibitive Action



Mandatory Action



## WARNING



### ELECTRICAL SHOCK HAZARD

**Do not open the equipment unless totally familiar with electrical circuits.**

Only qualified personnel should work inside the equipment.



**Turn off the power at the switchboard before beginning the installation.**

Fire or electrical shock can result if the power is left on.



**Be sure that the power supply is compatible with the voltage rating of the equipment.**

Connection of an incorrect power supply can cause fire or damage the equipment.



**If your vessel is configured with an autopilot system, install an autopilot control unit (or emergency autopilot stop button) at each helm station, to allow you to disable the autopilot in an emergency.**

If the autopilot cannot be disabled, accidents may result.



## CAUTION



Ground the equipment to prevent electrical shock and mutual interference.



**Use the proper fuse.**

Use of an incorrect fuse may damage the equipment.



**The front panel is made of glass. Handle it with care.**

Injury can result if the glass breaks.



Observe the following compass safe distances to prevent interference to a magnetic compass:

Model	Standard compass	Steering compass
TZTBBX	0.35 m	0.30 m



**This equipment uses the non-isolated power circuit. Appropriate circuit isolation is required when using both AC and DC power supply. Especially, when using the following ports, use an AC-DC converter or an isolated DC-DC converter, etc. Ground the negative terminal of the converter's output.**

- HDMI IN port
- USB1 port
- MULTI port
- HDMI OUT port
- USB2 port

 **CAUTION**



**Be sure to attach caps to all unused connectors.**

The unit may be damaged. Electrical shock can result.



**Do not connect/disconnect the cables connected to the unit while the power is turned on.**

The unit may be damaged.

# SYSTEM CONFIGURATION

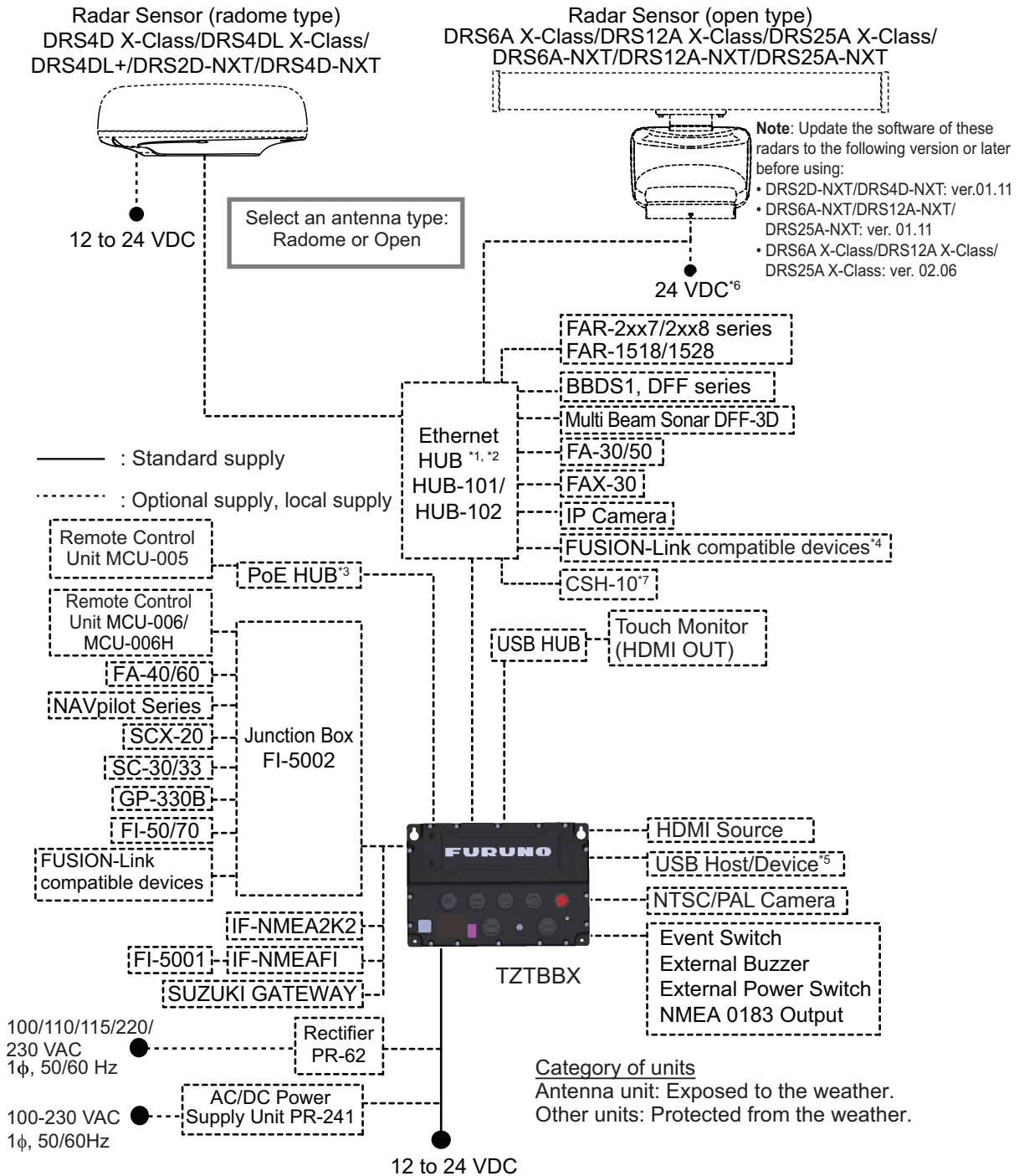

\*1: For the multi-stage (cascade) connection, a maximum of four units of HUB-101/HUB-102 can be connected to the MFDs.

\*2: With the Ethernet HUB, up to six NavNet TZtouch series units can be connected (up to four units when the TZT2BB is included). NavNet TZtouch (TZT9/14/BB) and TZTL12F/15F of NavNet TZtouch2 cannot be connected. For connection combinations, see "TZT series network connections" at the end of this chapter for details.

\*3: Use a commercially available PoE HUB. The NETGEAR GS108PE has tested as compatible. The basic functions of the hub were verified, however the compatibility of all functions were not checked. FURUNO cannot guarantee proper operation.

\*4: Available when FUSION-Link compatible equipment is connected via Ethernet.

\*5: When connected to a USB host device using USB OTG (USB), this unit operates as a touch operation output device.

\*6: Only DRS6A-NXT supports 12 to 24 VDC

\*7: The software version of the CSH-10 must be "Ver. 01.02" or later.

**TZT series network connections**

The TZT series can be connected on the same network in the following combinations.

	<b>TZtouch: TZT9/14/ BB</b>	<b>TZtouch2: TZTL12F/ 15F</b>	<b>TZtouch2: TZT2BB<sup>*1</sup></b>	<b>TZtouch3: TZT9F/12F/ 16F/19F<sup>*2</sup></b>	<b>TZMAP9/ 13</b>	<b>TZT9E/ 13E<sup>*3</sup></b>
TZtouchXL: TZTBBX/10X/13X/ 16X/22X/24X	No	No	Yes	Yes	No	Yes

<sup>\*1</sup>: Version 9.90 or later

<sup>\*2</sup>: Version 3.90 or later

<sup>\*3</sup>: Version 25.21 or later

**XX series Definition**

In this manual, the term “XX series” refers to the following models.

NavNet TZtouch series
TZT10X, TZT13X, TZT16X, TZT22X, TZT24, TZTBBX, TZT9F, TZT12F, TZT16F, TZT19F, TZT2BB, TZT9E, TZT13E
DFF series
DFF1, DFF1-UHD, DFF1UHD, DFF3
FAR-2xx7 series
FAR-2117, FAR-2127, FAR-2817, FAR-2827, FAR-2137S, FAR-2837S, FAR-2827W, FAR-2837SW
FAR-2xx8 series
FAR-2218(-BB), FAR-2228(-BB), FAR-2318, FAR-2328, FAR-2238S, FAR-2338S, FAR-2328W, FAR-2338SW, FAR-2228-NXT(-BB), FAR-2328-NXT, FAR-2238S-NXT(-BB), FAR-2338S-NXT

# EQUIPMENT LISTS

## Standard supply

Name	Type	Qty	Remarks
Multi Function Display	TZTBBX	1	Including installation materials, accessories and spare parts.

## Optional supply

Name	Type	Remarks
NMEA Data Converter	IF-NMEA2K2	
Remote Control Unit	MCU-005	
	MCU-006	
	MCU-006H	
Junction Box	FI-5002	
Analog NMEA Data Converter	IF-NMEA FI	
Wind Transducer	FI-5001	
Ethernet HUB	HUB-101	
	HUB-102	
Joint Box	TL-CAT-012	For LAN network
Rectifier	PR-62	100 VAC
		110 VAC
		220 VAC
		230 VAC
AC/DC Power Supply Unit	PR-241	
Ferrite Core	OP86-11	For PR-241
External Buzzer	OP03-136	Buzzer: PKB5-3A40
Network (LAN) Cable	FRU-RZWPNWP-002G	Single connector waterproofed
	FRU-RZWPNWP-005G	
	FRU-RZWPNWP-010G	
	FRU-RZWPWP-002G	Dual connector waterproofed
	FRU-RZWPWP-005G	
	FRU-RZWPWP-010G	
Connector	RZCDP08G5E-KLG7001	Waterproofed RJ45 plug
MULTI Cable	FRU-CCCAF14-R001G	
NMEA Cable Assy.	FRU-NMEA-PMMFF-010	1 m, two connectors
	FRU-NMEA-PMMFF-020	2 m, two connectors
	FRU-NMEA-PMMFF-060	6 m, two connectors
	FRU-NMEA-PFF-010	1 m, single connector
	FRU-NMEA-PFF-020	2 m, single connector
	FRU-NMEA-PFF-060	6 m, single connector
	FRU-MM1MF1MF1001	T connector
	FRU-MM1000000001	Male, terminator
	FRU-MF000000001	Female, terminator
Cable Assy.	FRU-HDDAP-005G	HDMI cable
USB Cable	FRU-UPCAP300UB-005BG	USB-A/USB-B cable
	FRU-UAP300UAJC-30G	USB-A/USB-A cable

<b>Name</b>	<b>Type</b>	<b>Remarks</b>
USB OTG Cable	FRU-MAEF05-MBJ0300G	Micro USB cable
User's Guide	E42-02210-*	For MCU-006
Operator's Manual	OME-45240-*	

# 1. MOUNTING

---

## 1.1 Mounting Considerations

When selecting a mounting location, keep the following points in mind:

- Install the units indoors.
- Locate the units away from water splash.
- The operating temperature range of the processor unit is -15°C to 55°C (5°F to 131°F). Be sure the mounting location satisfies this requirement.
- Locate the units away from exhaust pipes and vents.
- The mounting locations should be well ventilated.
- Mount the units where shock and vibration are minimal.
- Keep the units away from electromagnetic field-generating equipment such as motors and generators.
- Referring to the outline drawings at the back of this manual, leave sufficient room for service and maintenance. Also, leave slack in cables for maintenance and servicing ease.
- A magnetic compass may receive interference if it is placed too close to these units. Observe the compass safe distances noted in the safety instructions to prevent interference to the magnetic compass.
- The processor unit is equipped with an internal LAN antenna and should be installed in a location where the signal is not interrupted or halted by obstructions. **If you cannot install the processor in an obstruction-free location**, connect the processor unit to a wireless LAN router via LAN cable to establish an ETHERNET connection.

## 1.2 Security Risk Considerations

To reduce the risk of theft and ensure the security, it is recommended to take the following measures:

- Secure the unit to the mounting location using a cable lock to prevent unauthorized removal of the unit.
- Install the unit in a locked location on the ship so that it cannot be easily taken out.
- Use a port blocker to block the unused LAN ports on the HUB and physically prevent unauthorized access via the network. If not blocked, the data transmission on the LAN may be intercepted.
- To prevent accidental operation, unauthorized operation while away from your seat, unauthorized use of stolen product, and leakage of information saved in this unit, the NavNet TZtouchXL and smart devices that can control this unit must be locked by PIN code.
- Do not answer a scam phone call that asks for the access code of the TeamViewer. FURUNO never call you directly.

- Due to the specifications of the NMEA 2000, the transmission data can be intercepted and tampered. Check regularly to make sure that no suspicious devices are connected to the NMEA 2000 network.
- Incidents and accidents exploiting the AIS/DSC signals are reported. Never rely solely on the received signals and messages on the screen. Always maintain a vigilant watch while underway.

## 1.3 How to Install the Processor Unit

The Processor Unit (TZTBBX) must be installed on a flat surface (such as a floor mount) or on a bulkhead.

### 1.3.1 Bulkhead installation

1. Referring to the outline drawing at the back of this manual, drill four holes for the mounting screws (self-tapping  $\phi 5 \times 20$ , supplied as installation materials).
2. Fit two screws to the upper holes, leaving sufficient thread exposed to hang the processor unit.
3. Hang the processor unit on the two fitted screws, taking care that the processor is correctly oriented, with the cables and connectors facing downwards.

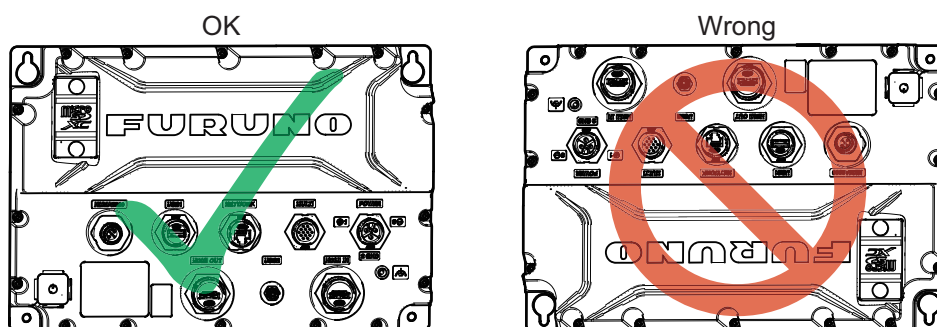

4. Loosely fasten two screws to the bottom two holes.
5. Fasten all four screws evenly, securing the processor unit to the installation location.

### 1.3.2 Flat surface (floor mount) installation

1. Referring to the outline drawing at the back of this manual, drill four holes for the mounting screws (self-tapping  $\phi 5 \times 20$ , supplied as installation materials).
2. Fit two screws to the upper holes, leaving sufficient thread exposed to fit the processor unit.
3. Slide the processor unit on the two fitted screws.
4. Loosely fasten two screws to the bottom two holes.
5. Fasten all four screws evenly, securing the processor unit to the installation location.

## 2. WIRING

### 2.1 Precautions for Tabletop Mounting

When wiring on the tabletop mounting, be sure to secure the cable near the processor unit so that there is no load on the connector due to vibration of the cable (see figure below).

When connecting the power cable, be sure to also connect the grounding wire (see section 2.2).

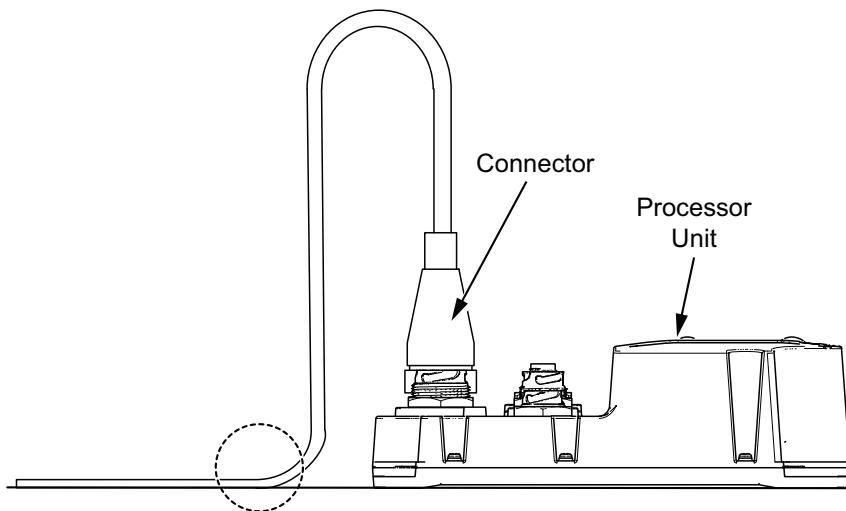

### 2.2 Interface Connections (rear of the unit)

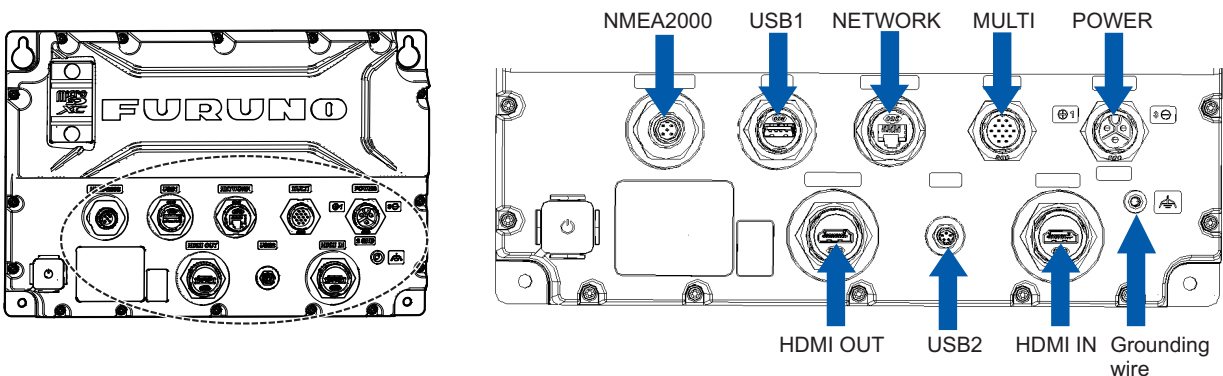

#### **Analog video input**

The TZTBBX can use regular analog video inputs (PAL or NTSC) that connect to the TZTBBX directly via the Video In connector on the optional MULTI cable (connected to the MULTI port). Analog video can be viewed only on the equipment where the source is connected.

Additionally a single FLIR camera may be connected to the TZTBBX. Connect the Video Out cable from the camera to the Video In connector on the optional MULTI cable (connected to the MULTI port).

Set up the analog video input from the [Settings] - [Camera & Video] menu. For details about analog video input settings, see the Operator's Manual (OME-45240).

**Note:** Some camera models may require an adapter for connection.

### **Network**

You can connect to an external network device using a LAN cable. Use HUB-101 or HUB-102 (option) when connecting multiple devices. The MCU-005 can also be connected via a PoE hub.

**Note:** If you cut off the waterproofed plug on the LAN cable to pass the cable through a pipe, etc., attach the optional waterproofed RJ plug (RZCDP08G5E-KLG7001) after routing the cable, referring to the following figure.

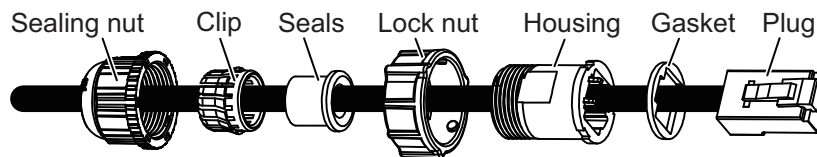

### **Video out (external HDMI monitor)**

The TZTBBX is compatible with wide-screen HDMI monitors which meet the following minimum requirements:

Resolution	Vertical Frequency	Horizontal Frequency	Pixel clock
1920 × 1080	60 Hz	67.5 kHz	148.5 MHz
1280 × 1024		64.0 kHz	108.0 MHz
1024 × 768		48.4 kHz	65.0 MHz

### **Video in (HDMI source devices)**

Video data from HDMI source devices can be watched on TZTBBX by connecting the device.

**Note:** To use the HDMI IN port, open the home page → [Settings] → [Camera & Video], then turn on [Connected]\* for [HDMI INPUT]. If this port is not used, turn off [Connected].

\*: When the PIN code lock is activated, enter the PIN code to change the setting.

### **NMEA2000 (CAN bus) port**

TZTBBX can be connected to multiple compatible NavNet TZT units using a micro type NMEA 2000 connector. In that case, connect them all to the same network backbone cable (Refer to section 2.7 for details).

### **MULTI port**

You can connect to external devices such as buzzers and event switches. Refer to section 2.4 for details.

### **USB port**



The TZTBBX has one USB Ver. 2.0 port ([USB 2] in figure on the page 3) and one USB Ver. 3.0 ([USB 1] in figure on the page 3) port which can be used to connect a remote control unit and/or to control a touch monitor.

## 2.3 Power Cable

Connect the power cable (FRU-3P-FF-A002M-003R, 2 m, supplied) to the connector. When connecting the power supply, connect the positive and negative terminals correctly.

**Note 1:** Turn off the power at the switchboard before beginning the connection.

**Note 2:** Connect the ground/shield wire of the power cable to the ship's ground.

 <b>CAUTION</b>		
	<p>This equipment uses the non-isolated power circuit. Appropriate circuit isolation is required when using both AC and DC power supply. Especially, when using the following ports, use an AC-DC converter or an isolated DC-DC converter, etc. Ground the negative terminal of the converter's output.</p>	
	<ul style="list-style-type: none"> <li>• HDMI IN port</li> <li>• USB2 port</li> </ul>	<ul style="list-style-type: none"> <li>• HDMI OUT port</li> <li>• MULTI port</li> <li>• USB1 port</li> </ul>

## 2.4 MULTI Cable

Use the optional MULTI cable to connect to the NMEA 0183 equipment, external buzzer, etc. The cable has 14 wires and a connector (SMP-11V). Use the table below for reference and connector (SMD-11V, local supply) when connecting the MULTI cable.



Wire color	Function	Description
White	NMEA-TD-B	NMEA 0183 Output
Blue	NMEA-TD-A	
Gray	BUZZER	External buzzer ON/OFF
Red	12 V_OUT+	External buzzer power (12 V)
Orange	EVENT_SW	Event switch (MOB, etc.)
Black	GND	Grounding for +12V/EVENT_SW
Purple	PWR_SW	Power switch
Brown	KPI	5-12 VDC, Positive
Red/White	KPO	12 VDC, Positive
Black/White	GND	Grounding for KP
Brown/White	GND	Grounding for power switch
Braided (external)	SHIELD	FG
Signal	Signal	For video input (RCA Jack)
Braided (internal)	GND	For video signal

### 2.4.1 How to set up NMEA 0183 data output

**Note:** To set up data input from NMEA 0183 equipment, see "NMEA 0183 equipment data input" on page 9.

1. Tap the [FURUNO] icon (  ) to show the home screen.
2. Tap [Settings], then drag the menu to show [Initial Setup]. Tap [Initial Setup].
3. Tap [Data Sensors], then tap [NMEA0183 Output].

**Note:** When the PIN code lock is activated, enter the PIN code to change the [NMEA0183 Output] settings.

4. Tap [Baud Rate] to set the output baud rate. Available options are [4,800], [9,600] and [38,400].
5. Tap the appropriate setting then tap the  icon.
6. Tap [NMEA-0183 Version] to set the version. Available options are [1.5], [2.0] and [3.0].
7. Tap the appropriate setting then tap the  icon.
8. Select the sentences to output. Tap a sentence, then tap its flipswitch to set the sentence to [ON].
9. Tap the [Close] icon at the top right of the screen to close the menus.

## 2.5 DRS Radar Sensor Connections

The figures below show connection examples with radar sensors which are compatible with the TZTBBX.

For details regarding connection and cables required for connection with the radar sensor, see the radar sensor's installation manual.

Connection examples for radome sensors

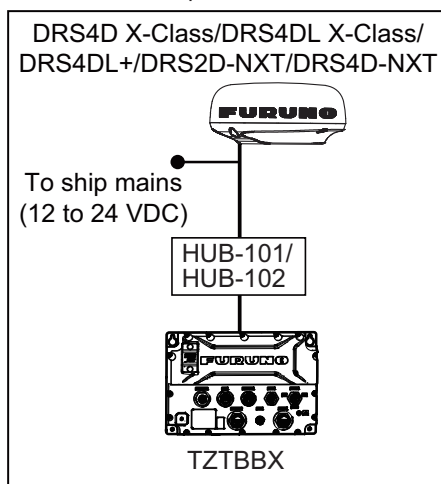

Connection examples for open-array sensors

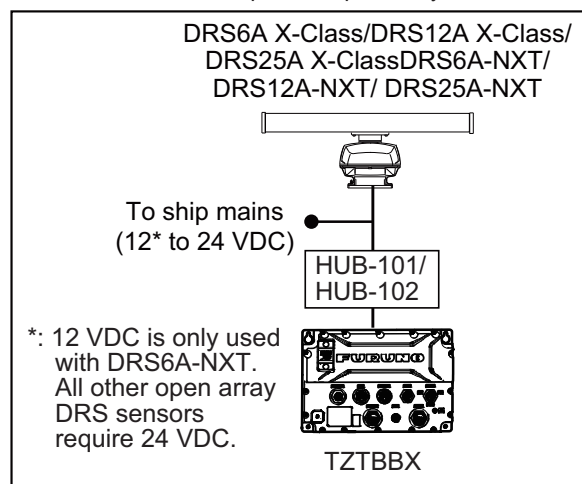

## 2.6 Network Connection with Other TZT Series Units

Your TZTBBX is equipped with a network connector (RJ45). Like previous NavNet series equipment, the TZTBBX is able to share Radar images and other information, across an Ethernet connection. Up to six NavNet TZtouch units may be connected to the same network at one time (see page iv for the details). However, for configurations with one or more TZT2BB included, the maximum number of networked NavNet TZtouch units is four. For example, a configuration with one TZTBBX and one TZT12F can have two TZT2BB units connected.

## 2.7 NMEA 2000 Connector

The TZTBBX has one NMEA 2000 connector (micro type connector). All TZTBBX must be connected to the same NMEA 2000 backbone.

### What is NMEA 2000?

NMEA 2000 (also known as CAN bus) is a communication protocol that shares multiple data and signals through a single backbone cable. You can simply connect any NMEA 2000 devices onto the backbone cable to expand your network on-board. With NMEA 2000, IDs are assigned to all the devices in the network, and the status of each sensor in the network can be detected. All the NMEA 2000 devices can be incorporated into the NMEA 2000 network. For detailed information about NMEA 2000 wiring, see "FURUNO CAN bus Network Design Guide" (Type: TIE-00170).

### 2.7.1 How to connect the NavNet TZtouchXL to NMEA 2000 equipment

Below is an example of two units, connected to NMEA 2000 sensors via the network.

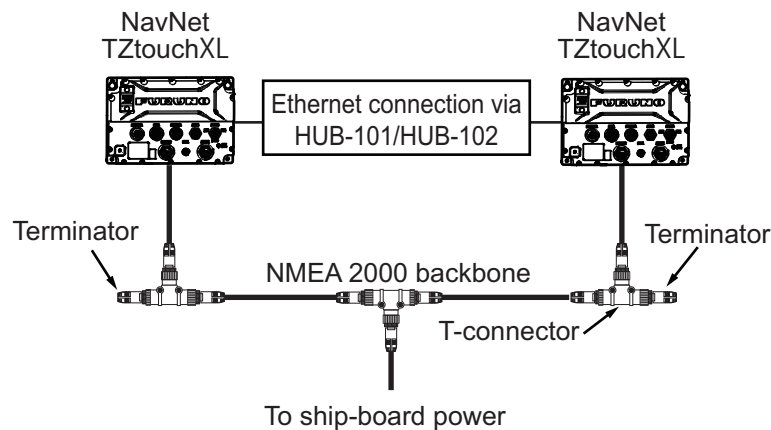

**Note 1:** The NMEA 2000 network requires a dedicated NMEA 2000 power supply. Turn the NMEA 2000 network power on before turning your connected equipment on.

**Note 2:** Terminators must be installed at both ends of the NMEA 2000 backbone cable. See the "EQUIPMENT LISTS" on page v for available terminators.

## 2.7.2 How to connect YAMAHA engine(s)

When interfaced with outboard engine(s) compatible with Command Link®, Command Link Plus® and Helm Master®, the TZTBBX can display engine information on a dedicated YAMAHA engine status display. See the Operator’s Manual (OME-45240) for details on the YAMAHA engine status display.

### How to connect the engine

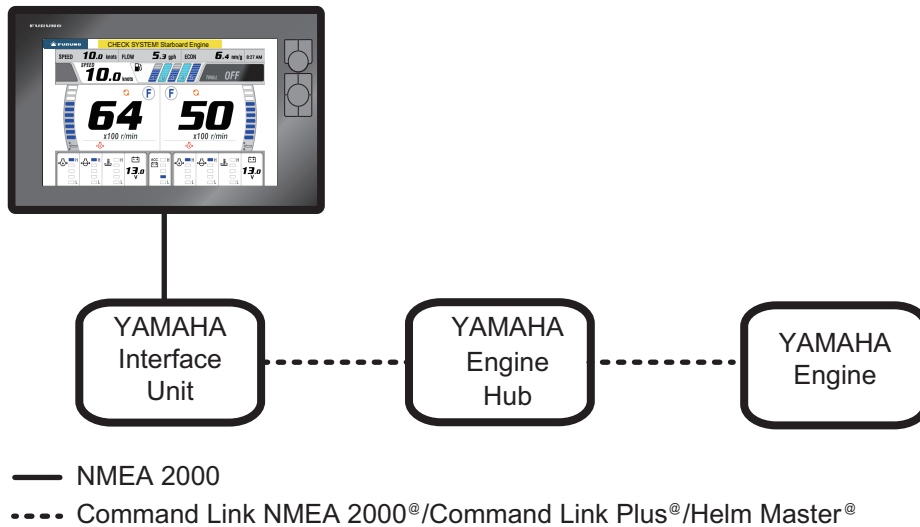

The TZT10X/13X connects to the YAMAHA engine network via the YAMAHA Interface Unit. Arrange the YAMAHA Interface Unit through a local YAMAHA representative.

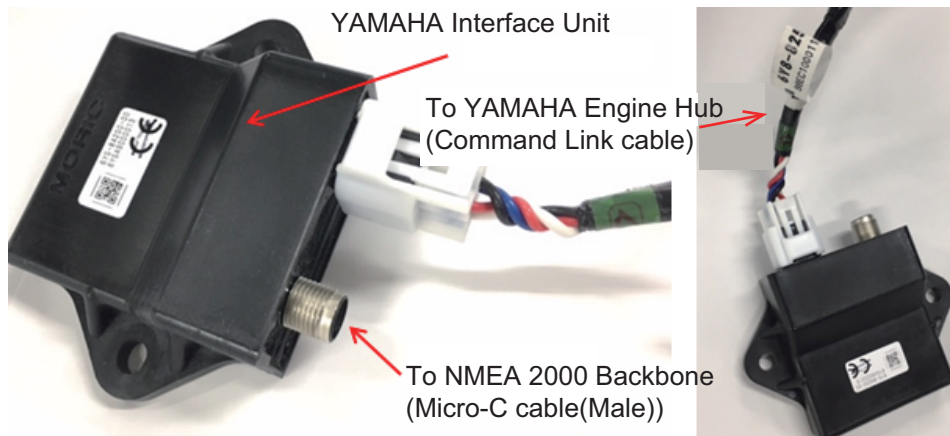

The YAMAHA Engine Hub (YAMAHA supply), which connects between the engine and the YAMAHA Interface Unit, is also required.

## 2. WIRING

YAMAHA Engine Hub

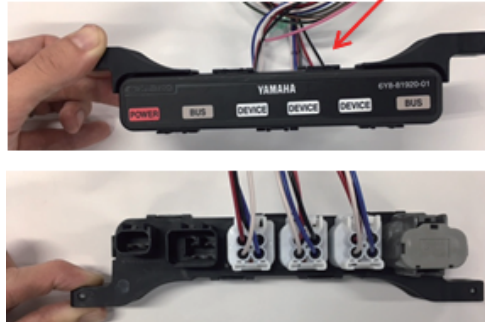

### How to set up the engine display

Once the TZTBBX detects the YAMAHA engine network, the engine can be set up on [Settings]→[Initial Setup]→[YAMAHA ENGINE SETUP]. See "[YAMAHA ENGINE SETUP] section" on page 24 for details.

### 2.7.3 NMEA 0183 equipment data input

**Note:** To output NMEA 0183 data, see section 2.4.1.

To connect NMEA 0183 equipment to TZTBBX, use the NMEA 2000 network via the optional NMEA data converter IF-NMEA2K2 (or IF-NMEA2K1). This NMEA connection can accept a baud rate of 4800 or 38400.

Heading input to TZTBBX allows functions such as Radar Overlay and course stabilization (North up, etc.) in the radar operating modes. The NMEA 0183 heading refresh rate needs to be 100 ms in order for any radar function to work properly. NMEA 0183 heading can be accepted on any NMEA 2000 port at a baud rate up to 38400 bps.

**Note 1:** When using the ARPA function, set the heading refresh rate to 100 ms.

**Note 2:** For more information on connecting and wiring IF-NMEA2K2, refer to their respective installation manuals.

### 2.7.4 NMEA 2000 input/output

#### Input PGN

PGN	Description
059392	ISO Acknowledgment
059904	ISO Request
060160	ISO Transport Protocol, Data Transfer
060416	ISO Transport Protocol, Connection Management - BAM group function
060928	ISO Address Claim
061184	Self Test Group Function (Proprietary PGN)
065240	ISO Commanded Address
065280	Heave (Proprietary PGN)
126208	NMEA-Request Group Function
	NMEA-Command Group Function
	NMEA-Acknowledge Group Function
126464	PGN List - Transmit PGN's group function
126720	Memory Clear Group Function (Proprietary PGN)
126983	Alert

<b>PGN</b>	<b>Description</b>
126985	Alert Text
126992	System Time
126996	Product Information
126998	Configuration Information
127237	Heading/Track Control
127245	Rudder
127250	Vessel Heading
127251	Rate of Turn
127252	Heave
127257	Attitude
127258	Magnetic Variation
127488	Engine Parameters, Rapid Update
127489	Engine Parameters, Dynamic
127493	Transmission Parameters, Dynamic
127498	Engine Parameters, Static
127501	Binary Status Report
127503	AC Input Status
127505	Fluid Level
127506	DC Detailed Status
127508	Battery Status
128259	Speed
128267	Water Depth
129025	Position, Rapid Update
129026	COG & SOG, Rapid Update
129029	GNSS Position Data
129033	Local Time Offset
129038	AIS Class A Position Report
129039	AIS Class B Position Report
129040	AIS Class B Extended Position Report
129041	AIS Aids to Navigation (AtoN) Report
129291	Set & Drift, Rapid Update
129538	GNSS Control Status
129540	GNSS Satellites in View
129793	AIS UTC and Date Report
129794	AIS Class A Static and Voyage Related Data
129795	AIS Addressed Binary Message
129797	AIS Binary Broadcast Message
129798	AIS SAR Aircraft Position Report
129801	AIS Addressed Safety Related Message
129802	AIS Safety Related Broadcast Message
129808	DSC Call Information
129809	AIS Class B "CS" Static Data Report, Part A
129810	AIS Class B "CS" Static Data Report, Part B
130306	Wind Data
130310	Environmental Parameters
130311	Environmental Parameters
130312	Temperature
130313	Humidity
130314	Actual Pressure

2. WIRING

PGN	Description
130316	Temperature, Extended Range
130576	Trim Tab Status
130577	Direction Data
130578	Vessel Speed Component
130817	Furuno GNSS Control Status (Proprietary PGN)
130818	Heading & Attitude Sensor Control Status (Proprietary PGN)
130820	Motion Sensor Status(Proprietary PGN)
130822	Unit Division Code(Proprietary PGN)
130823	Browser Control Status(Proprietary PGN)
130826	Multi Sats In View (Proprietary PGN)
130827	NAVpilot General Message (Proprietary PGN)
130828	Mark Position Information(Proprietary PGN)
130845	Multi Sats in View Extended (Proprietary PGN)
130846	Motion Sensor Status Extended (Proprietary PGN)
130880	Additional Weather Data(Proprietary PGN)

**Output PGN**

The NMEA 2000 output PGN setting (found under the [Initial Setup] menu) is global to the network. Note that only one TZTBBX will output NMEA 2000 data on the network at a time: the TZTBBX which is powered ON first. If that display is turned OFF, another will take its place to output the data.

PGN	Description	Output cycle (msec)
059392	ISO Acknowledgement	
059904	ISO Request	
060928	ISO Address Claim	
061184	Self Test Group Function (Proprietary PGN)	
065287	HID Target Status (Proprietary PGN)	
126208	NMEA-Request group function	
	NMEA-Command group function	
	NMEA-Acknowledge group function	
126464	PGN List-Transmit PGN's group function	
	PGN List-Received PGN's group Function	
126720	Memory Clear Group Function (Proprietary PGN)	
126984	Alert Response	
126992	System Time	1000
126993	Heartbeat	60000
126996	Product Information	
126998	Configuration Information	
127250	Vessel Heading	100
127251	Rate of Turn	100
127257	Attitude	1000
127258	Magnetic Variation	1000
128259	Speed	1000
128267	Water Depth	1000
128275	Distance Log	1000
129025	Position, Rapid Update	100
129026	COG & SOG, Rapid Update	250

<b>PGN</b>	<b>Description</b>	<b>Output cycle (msec)</b>
129029	GNSS Position Data	1000
129033	Local Time Offset	1000
129283	Cross Track Error	1000
129284	Navigation Data	1000
129285	Navigation-Route/WP information	
130306	Wind data	100
130310	Environmental Parameters	500
130312	Temperature	2000
130313	Humidity	2000
130314	Actual Pressure	2000
130316	Temp., Extended Range	2000
130821	NAV Source Select (Proprietary PGN)	
130822	Unit Division Code (Proprietary PGN)	
130823	Browser Control Status (Proprietary PGN)	
130827	NAVpilot General Message (Proprietary PGN)	
130841	N2K System Setup Information (Proprietary PGN)	

## 2.8 Example TZTBBX System Configuration

### Mid/Large-size vessels (External GPS, Fish Finder, Radar)

This is a sample of the chart plotter/radar/fish finder installation. Refer to "SYSTEM CONFIGURATION" on page iii for more details.

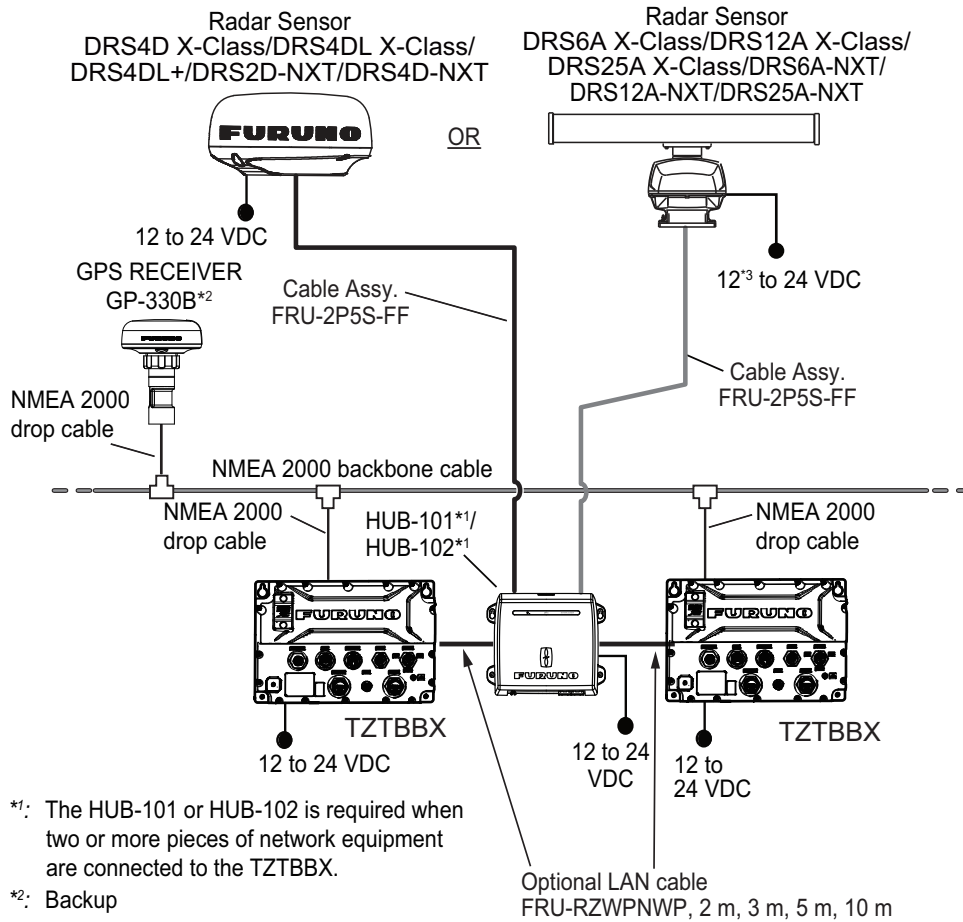

- \*1: The HUB-101 or HUB-102 is required when two or more pieces of network equipment are connected to the TZTBBX.
- \*2: Backup
- \*3: 12 VDC is only used with DRS6A-NXT. All other open array DRS sensors require 24 VDC.

## 2.9 SUZUKI Outboard Motor Connection

The NavNet TZtouchXL can display the SUZUKI engine information by connecting a SUZUKI outboard motor compatible with the CAN2 network system. For details regarding the SUZUKI engine display, see your Operator's Manual or eGuide.

To connect the SUZUKI outboard engine, following equipment is required. For how to purchase and connect the equipment, contact a SUZUKI Motor Corporation dealer.

- SUZUKI gateway (34923-96L1\*)
- Dual gauge adapter (36667-96L4\*)
- SUZUKI multi-function gauge (SMG4)

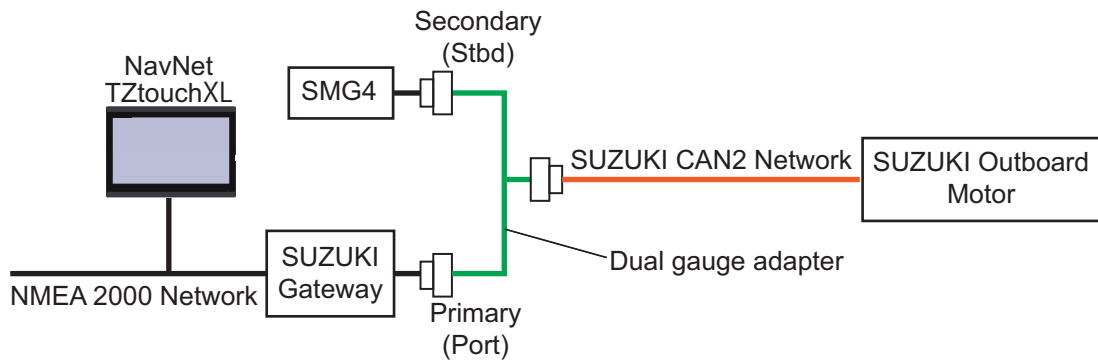



**Note:** The NavNet TZtouchXL is compatible with DBW-type outboard motors manufactured in 2022 or later, and mechanical-type outboard motors manufactured in 2023 or later. For details of compatible modes, contact a SUZUKI Motor Corporation dealer.

# 3. HOW TO SET UP THE EQUIPMENT

This chapter shows you how to set up your system according to the equipment you have connected.

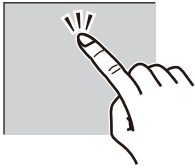
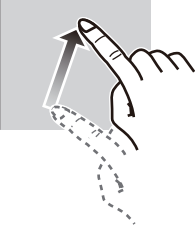

## Touch control description

The touch control depends on the screen type. The basic operations to use during the installation setup are in the following table.

Operating by a finger		Function
Tap		<ul style="list-style-type: none"> <li>• Select a menu item.</li> <li>• Select a setting option where there are multiple options.</li> <li>• Select an object.</li> <li>• Display the pop-up menu where available.</li> </ul>
Drag		<ul style="list-style-type: none"> <li>• Scroll the menu.</li> </ul>
Pinch	  Zoom in                  Zoom out	Change the fish finder, plotter and radar range.

## How to operate the menus

The following procedure shows how to use the menu system.

1. Tap  (power switch) to turn the power on.
2. After the startup process completes, the last used display appears and a warning message is displayed. Read the message, then tap [OK].
3. Tap the [FURUNO] icon (  ) to show the home screen and display mode settings.

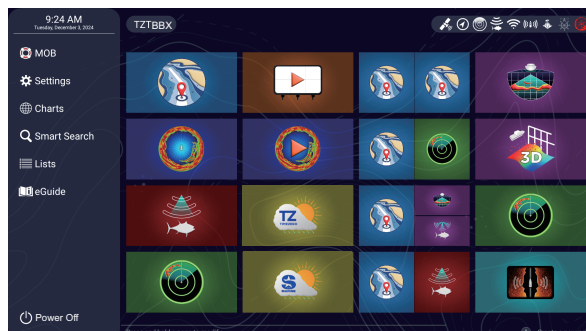

4. Tap [Settings] to open the [Settings] menu.
5. Drag the menu to show [Initial Setup], then tap [Initial Setup].

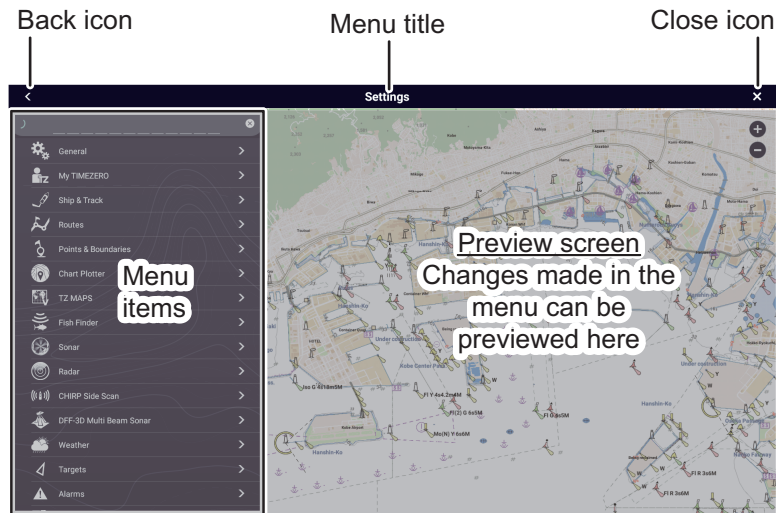

6. Depending on the menu item selected, the following operations are available:

- ON/OFF flipswitch. ON Fuel Range Ring  
OFF Fuel Range Ring

Tap to switch between [ON] and [OFF] to activate or deactivate the function.

- Slidebar and keyboard icon.

Drag the slidebar to adjust the setting. Settings may also be adjusted using the software keyboard for direct input.

- Keyboard icon.

Referring to the following figure, use the software keyboard to input alphabet or numeric characters.

7. Tap [Close] (Indicated as an "X") at the top right-hand side of the screen to exit.

### How to use the software keyboard

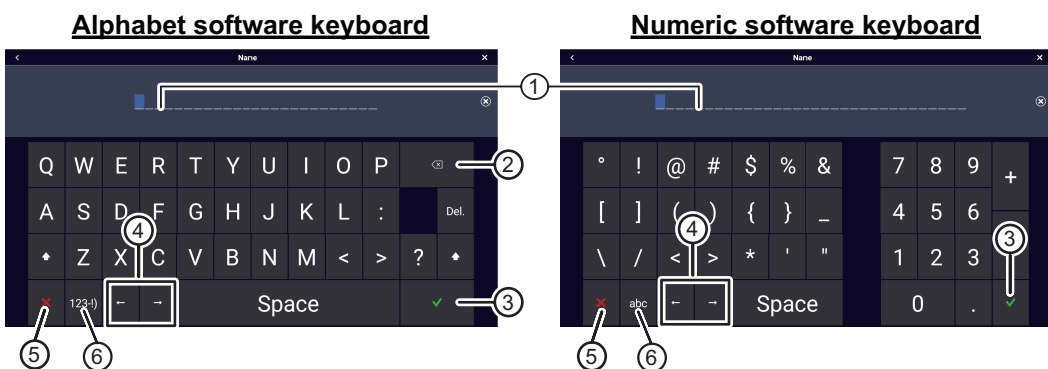

No.	Description
1	Cursor position is highlighted.
2	Backspace/Delete. Tap to erase one character at a time.
3	Enter button. Tap to complete character input and apply changes.
4	Cursor keys. Tap to move the cursor left/right.
5	Cancel button. Aborts character entry. No changes are applied.
6	Tap to switch between alphabet and numeric keyboards (where available).

### 3.1 How to Manage Device Communication

When a new device is detected, the following pop-up message appears. Select [ALLOW] to allow the communication with the device. If an unauthorized device is detected, select [DENY] to prohibit the communication.

**Note:** For the TZTBX, you can use the USB device for 30 minutes after it is detected even if the connection permission is not set. If you do not set the connection permission, the connection with the device will be automatically disconnected after 30 minutes. Restart the TZTBX to use the device again and set the connection permission.

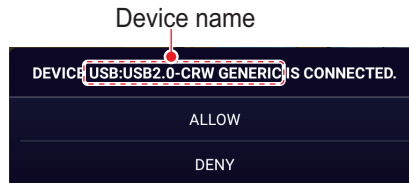

For the device to be prohibited the communication, the prohibition icon (🚫) appears to the left of the sensor name on the sensor list. To show the sensor list, open the home page → [Settings] → [Initial Setup] → [Data Sensors] → [Sensor List].

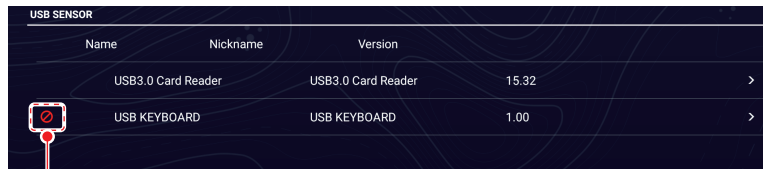

Indicates that the communication of this device is prohibited.

To allow the communication, tap the device on the sensor list then turn on [Permission to use]\*.

\*: When the PIN code lock is activated, enter the PIN code to change the setting.

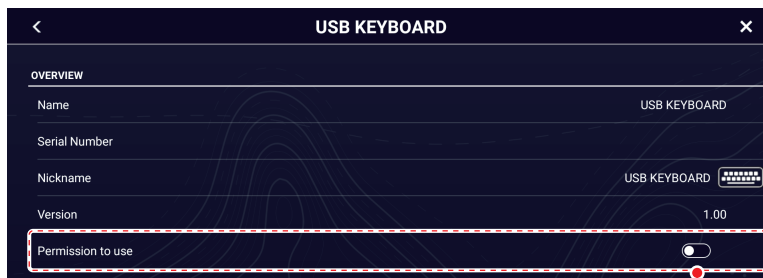

Turn on this setting to allow the communication with the device.

## 3.2 How to Set Time Zone, Time Format and Language

Before setting up your equipment, select the time zone, language and units to use on your equipment as shown below.

1. Tap the [FURUNO] icon (  ) to show the home screen and display mode settings.
2. Tap [Settings] to show the [Settings] menu.
3. Tap [General] to show the [General] menu.
4. Tap [Local Time Offset] to show the numerical keyboard.
5. Input the time difference (using 15-minute intervals) between local and UTC, then tap [✓].
6. Drag the menu to show the [Time Format] menu item, then tap [Time Format] to show the option window.
7. Select how to display time, in 12- or 24-hour format. [Auto] automatically inserts AM, PM indication in 24 hour clock, when the language is English.
8. Tap the [<] at the top left of the screen to return to the [General] menu.
9. Tap [Language] to show the [Language] menu.

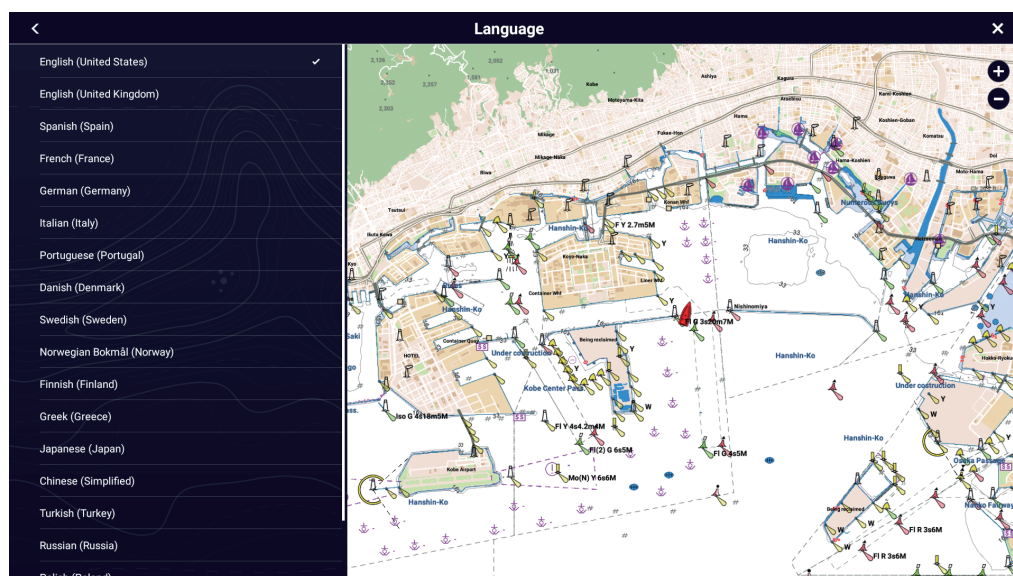

10. Tap the appropriate language to use. The unit will display a confirmation message. Tap [OK] to restart the unit and apply the new language settings. This process takes approximately five minutes to optimize the system for the new language setting. When the process is completed (five minutes later), the system restarts automatically.

### 3.3 How to Set Units of Measurement

1. Tap the [FURUNO] icon (  ) to show the home screen and display mode settings.
2. Tap [Settings] to show the [Settings] menu.
3. Drag the main menu to display [Units], then tap [Units].
4. Referring to the table below, set the units to show on the display.

Menu item	Description	Options
[Bearing Display]	Adjust the bearing display format.	[Magnetic], [True]
[True Wind Calculation Reference]	Set the reference for calculating true wind speed/angle.	[Ground], [Surface]
[Position Format]	Set the display format for position (Latitude/Longitude).	[DDD°MM.mmmm'], [DDD°MM.mmm'], [DDD°MM.mm'], [DDD°MM'SS.ss"], [DDD.ddddd°], [Loran-C], [MGRS]
[Loran C Station &GRI]	Available when [Position Format] is selected to [Loran-C].	Set Loran C station and GRI combination.
[Short/Long Change Over]	Set the distance at which to change between short and long range.	[0.0] to [2.0] (NM)
[Range (Long)]	Set the unit of measurement for long distances.	[Nautical Mile], [Kilometer], [Mile]
[Range (Short)]	Set the unit of measurement for short distances.	[Foot], [Meter], [Yard]
[Depth]	Set the unit of measurement for depth.	[Foot], [Meter], [Fathom], [Passi Braza]
[Height/Length]	Set the unit of measurement for height and length.	[Foot], [Meter]
[Fish Size]	Set the unit of measurement for fish sizes.	[Inch], [Centimeter]
[Temperature]	Set the unit of measurement for temperature.	[Fahrenheit Degree], [Celsius Degree]
[Boat Speed]	Set the unit of measurement for boat speed.	[Knot], [Kilometer per Hour], [Mile per Hour], [Meter per Second]
[Wind Speed]	Set the unit of measurement for wind speed.	[Knot], [Kilometer per Hour], [Mile per Hour], [Meter per Second]
[Atmospheric Pressure]	Set the unit of measurement for atmospheric pressure.	[HectoPascal], [Millibar], [Millimeter of Mercury], [Inch of Mercury]
[Oil Pressure]	Set the unit of measurement for oil pressure.	[KiloPascal], [Bar], [Pound per Square Inch]
[Volume]	Set the unit of measurement for tank volume.	[Gallon] (Gallon &Gallon/hour), [Litre] (Litre &Litre/hour)
[Reset Default Settings]	Restore default unit settings.	[OK], [Cancel]

## 3.4 Initial Setup

This section shows you how to set your system according to the sensors you have connected.

**Note:** Some units are set to metric in this section, actual setting ranges vary depending on the unit of measurement set in the [Units] menu.

1. Tap the [FURUNO] icon (  ) to show the home screen and display mode settings.
2. Tap [Settings] to show the [Settings] menu.
3. Drag the main menu, then tap [Initial Setup] to show the [Initial Setup] menu.
4. Referring to the tables on the following pages, set your equipment.

### [Boat Information] section

Menu item	Description	Options (setting range)
[Boat Height]	Set the height of your boat.	0 (m) to 999 (m)
[Boat Width]	Set the width of your boat.	0 (m) to 999 (m)
[Boat Length]	Set the length of your boat.	0 (m) to 999 (m)
[Boat MMSI]	Set the MMSI for your boat (used for fleet tracking function only).	
[Boat Name]	Set the name for your boat (used for fleet tracking function only).	
[Size of Own Ship Icon]	Set the size of own ship icon.	50 to 150
[Depth Display]	Select the start point for depth measurement.	[Under Keel], [Under Sea Level]
[External Transducer Draft]	Set the draft for external transducers other than internal fish finder, networked or multi-beam sonar. <b>For internal/network transducers</b> , set the draft from Home screen → [Settings] → [Fish Finder] → [Fish Finder Initial Setup] → [Transducer Draft]. <b>For multi-beam sonars</b> , set the draft from Home screen → [Settings] → [Multibeam Sonar] → [Initial Setup] → [Transducer Draft].	0.0 (m) to 99.9 (m)
[Keel Draft]	Set the keel draft.	0.0 (m) to 99.9 (m)
[Engine Count]	Set the number of engines.	0 to 6
[Reset Default Page Settings]	Resets [Boat Information] menu settings to default.	[OK], [Cancel]

### [Instruments Setup] section



Menu item	Description	Options (setting range)
[Engine & Tank Automatic Setup]	See "[Engine & Tank Automatic Setup] section" on page 25.	
[Engine & Tank Manual Setup]	See "[Engine & Tank Manual Setup] section" on page 25.	
[Graphic Instruments Setup]	See "[Engine & Tank Automatic Setup] section" on page 25.	
[Switching]	See "[Switching] section" on page 27 .	

### 3. HOW TO SET UP THE EQUIPMENT

#### **[Manual Fuel Management] section**

Menu item	Description	Options (setting range)
[Total Fuel Capacity]	Enter the total fuel capacity of your tank(s).	0 to 9,999(L).
[Manual Fuel Management]	Set to [ON] for manual fuel management. See the Operator's Manual.	Off, On
[Reset Default Page Settings]	Resets [Manual Fuel Management] menu settings to default.	[OK], [Cancel]

#### **[Data Sensors] section**

Menu Item	Description	Options (setting range)
[Data Sources]	Select the source for each data to input to the system. If two or more sources are connected for a data, select one using the pull-down dialog box. The FURUNO products are shown at the upper part of the list.	
[Sensor List]	Show the information for sensors connected to your equipment. Tap the sensor to show the detailed information. You can edit the items with  icons on the right of the screen. <b>Note 1:</b> If you change an instance value, you need to restart its sensor. <b>Note 2:</b> If an unknown sensor appears on the sensor list, tap the sensor and check the detailed information. If it is an unauthorized sensor, turn off [Permission to Use]* to prohibit the communication. The prohibition icon (  ) appears to the left of the sensor name on the sensor list.	
[NMEA0183 Output]*	<ul style="list-style-type: none"> <li>[Baud Rate]: Select the baud rate.</li> <li>[NMEA-0183 Version]: Select the version for NMEA 0183.</li> </ul>	<ul style="list-style-type: none"> <li>[4,800], [9,600], [38,400]</li> <li>[1.5], [2.0], [3.0]</li> </ul>
	[Sentences]: Select the sentences to output. <b>Note:</b> If the TTM sentence is received at the same time as another sentence, the constraints to communication bandwidth may cause a decrease in the number of TTM targets.	Off, On
[NMEA2000 PGN Output]*	Turn On for the PGN's (Parameter Group Number, NMEA 2000 message) to output from the NMEA 2000 port. <b>Note:</b> The default setting of some PGNs is "On".	Off, On
[Sky View...]	Show the condition of GPS and GEO (WAAS) satellites on the [GPS SkyView] display. The bearing and elevation angle of all GPS and GEOsatellites (if applicable) in view of your receiver appear. For the service technician. <b>Note:</b> The [GPS SkyView] display can also be shown by tapping the GPS icon (shown right) on the Home page. 	
[GP330B WAAS Mode]	Turn On to use the WAAS mode for the corresponding GPS antenna.	Off, On
[WS200 WAAS Mode]		
[Reset Default Page Settings]	Resets [Data Sensors] menu settings to default.	[OK], [Cancel]

\*: When the PIN code lock is activated, enter the PIN code to change the setting.

**[Network Sensor Setup] section**

The [NETWORK SENSOR SETUP] section allows you to set up compatible FURUNO NMEA 2000 sensors. Calibrations and offsets applied in this menu are also applied to the sensor itself.

Tap the sensor to access its menus and settings. For details regarding the menu structure and set up of each sensor, see the appropriate operator's manual, supplied with the sensor.

Menu item	Description	Option (setting range)
[NAVpilot-300 (Processor...)]	When the NAVpilot-300 is connected in the NavNet TZtouchXL network, you can setup the NAVpilot from this equipment. For details regarding each menu item, see the NAVpilot Operator's Manual.	
[FAX-30 Browser]	Show the Facsimile Receiver FAX-30 display.	
[FA-30 Browser]	Show the AIS Receiver FA-30 display.	
[FA-50 Browser]	Show the AIS Receiver FA-50 display.	

**[SC-30 Setup] section (only when the SC-30 is connected)**

Menu item	Description	Options (setting range)
[WAAS Mode]	Turn On to use the WAAS mode.	Off, On
[Heading Offset]	Enter the offset value for heading.	-180° to +180°
[Pitch Offset]	Enter the offset value for pitching.	-90° to +90°
[Roll Offset]	Enter the offset value for rolling.	-90° to +90°

**[Data Offset] section**

Menu item	Description	Options (setting range)
[Heading]	Offset heading data.	-180.0° to +180.0°
[Speed Through Water]	Calibrate speed data. Enter amount in percentage.	-50% to +50%
[Wind Speed]	Offset wind speed data. Enter amount in percentage.	-50% to +50%
[Wind Angle]	Offset wind angle data.	-180° to +180°
[Sea Surface Temperature]	Offset sea surface temperature data.	-10°C to +10°C
[Reset Default Page Settings]	Resets [Data Offset] menu settings to default.	[OK], [Cancel]

**[GPS Position] section**

Menu item	Description	Options (setting range)
[Longitudinal (from bow)]	Referring to the figure on the right, enter the GPS antenna positioning bow-stern (Longitudinal) and port-starboard (Lateral) position from the origin.	0 (m) to 999 (m)
[Lateral (-Port)]		-99 (m) to +99 (m) Port-side is negative, Starboard-side is positive.
[Reset Default Page Settings]	Resets [GPS Position] menu settings to default.	[OK], [Cancel]



### 3. HOW TO SET UP THE EQUIPMENT

#### **[Data Damping] section**

Menu item	Description	Options (setting range)
[COG & SOG]	Set data damping time. The lower the setting the faster the response to change.	0 to 59 seconds
[Heading]		
[Speed Through Water]		
[Wind Speed & Angle]		
[Rate of Turn]		
[Reset Default Page Settings]	Resets [Data Damping] menu settings to default.	[OK], [Cancel]

#### **[IF-NMEA2000 Setup] section**

Menu item	Description	Options (setting range)
[Select IF]*	Select [IF-NMEA2000] to set the analog data that is input from the IF-NMEA2000. The setting is made after restarting the IF-NMEA2000.	
[Category]	Select the use (category) for this sensor.	[Wind], [ST800_850], [Fuel], [FreshWater], [WasteWater], [LiveWell], [Oil], [BlackWater]
[Resistance Full]	The resistance, in Ohms, when the tank is full.	0 (ohm) to 500 (ohm)
[Resistance Mid]	The resistance, in Ohms, when the tank is half full.	0 (ohm) to 500 (ohm)
[Resistance Empty]	The resistance, in Ohms, when the tank is empty.	0 (ohm) to 500 (ohm)
[Capacity]	The capacity of the tank.	0 (G) to 2650 (G)
[Fluid Instance]	Select the NMEA instance for the tank.	000 to 254
[Self test]	Test results are displayed.	
[Set Hardware to Factory Default]	Resets the converter selected at [Select IF] to factory default.	[OK], [Cancel]
[Reset Default Page Settings]	Resets [IF-NMEA2000 Setup] menu settings to default.	[OK], [Cancel]

\*: When the PIN code lock is activated, enter the PIN code to change the setting.

#### **[Fusion] section**

Menu item	Description	Options (setting range)
[Connect to Fusion]	Connects to your Fusion equipment.	
[Fusion Auto Volume]	Set to [On] to allow the TZTBX unit to control the FUSION volume automatically.	Off, On
[Minimum Speed]	Set the minimum speed threshold. Exceeding this speed activates volume auto control.	0.0 (kn) to 98.9 (kn)
[Maximum Speed]	Set the maximum speed threshold.	0.1 (kn) to 99.0 (kn)
[Volume Increase]	Set the amount of extra volume to output.	10% to 50%
[Reset Default Page Settings]	Resets [Fusion] menu settings to default.	[OK], [Cancel]

#### **[Service/Self Test/Log] section**

Menu item	Description	Option (setting range)
[Synchronization Log]	Shows synchronization with devices connected to the network.	
[Enable NMEA2000 Log]	Turn On when using NMEA 2000 log.	Off, On
[NMEA2000 Log Storage Location]	Show the location where to store the log.	
[Quick Self Test]	Displays various details regarding the TZTBX unit, radar and fish finder.	

Menu item	Description	Option (setting range)
[Certification Mark]	Displays relevant certification for this equipment.	
[Service]	Requires login password. For the service technician.	
[Reset Default Page Settings]	Resets [Service/Self Test/Log] menu settings to default.	[OK], [Cancel]

#### **[Home Page] section**

Menu item	Description	Options (setting range)
[Factory Reset]	Click [OK] to restore the [HOME] screen's default settings.	[OK], [Cancel]

#### **[YAMAHA ENGINE SETUP] section**

Menu item	Description	Options (setting range)
[Trip & Maintenance]	To reset fuel flow, trip distance, and maintenance time for each engine (trip hour, standard hour, optional hour, total hour), tap [Reset] for each item.	
[Trim Level Calibration]	Adjust when the displayed trim level differs from the actual trim level. When all engine trim angles are set to the lowest position (zero), tap [SET] to set the trim level to zero.	
[Fuel Flow Calibration]	If the fuel consumption display (gph = gallons per hour) is incorrect, you can adjust the value to show the correct flow rate. Enter a negative value if the displayed value is higher than the actual flow rate, or a positive value if lower than the actual flow rate.	-7 to +7
[Engine Interface Software Ver. & ID]	Display the software version and ID of the YAMAHA Engine Interface Unit.	
[Reset Engine Interface]	Reset the YAMAHA Engine interface unit.	
[Reset Engine Instance]	Reset the engine instance.	
[Reset Number of Engines]	Refer to the Operator's Manual of YAMAHA Engine and set the number of engines.	[1], [2], [3], [4], [4P], [4S]
[Trouble Codes]	Displays YAMAHA Engine trouble codes. For details, refer to the Operator's Manual of YAMAHA Engine.	
[Reset Default Page Settings]	Reset the [YAMAHA ENGINE SETUP] menu settings to default.	

#### **Other menu items**

Menu item	Description	Option (setting range)
[Chart Master Device]	Turn On to use this unit as the master, Off to use this unit as a slave. <b>Note 1:</b> If two or more TZT units are connected in the same network, set the chart master on only one TZT unit. <b>Note 2:</b> When two or more TZT units are connected in the same network, do not change this setting after completing the setup. If changed, it is necessary to obtain a new unlock code. For how to obtain a new unlock code, see the Operator's Manual.	
[System ID]	The system ID for this device within the network.	

### 3. HOW TO SET UP THE EQUIPMENT

Menu item	Description	Option (setting range)
[Event Input Configuration]	Set the function for the event switch. <ul style="list-style-type: none"> <li>• [Off]: Turns off the event switch function.</li> <li>• [Event Mark]: Inputs an event mark at the current position.</li> <li>• [MOB]: Inputs the MOB at the current position.</li> <li>• [Ferry mode (bow azimuth reversal)]: Turns ferry mode on or off.</li> </ul>	[OFF], [Event Mark], [MOB], [Ferry]
[Update Network Equipments]	For the service technician.	
[Remote Controller Configuration]	If you have multiple NavNet TZtouchXLs connected in the same network, select the display to operate with MCU-005, MCU-006/MCU-006H. Also, set the ranking of the display to be switched among the selected displays. See the Operator's Manual.	
[Sirius Radio Diagnostic]	Check the satellite radio of the FURUNO BBWX SiriusXM weather receiver for proper operation. See the Operator's Manual.	
[Sirius Weather Diagnostic]	Check the weather section of the FURUNO BBWX SiriusXM weather receiver for proper operation. See the Operator's Manual.	
[Reset Default Settings]	Reset the system to default settings.	[OK], [Cancel]

#### **[Engine & Tank Automatic Setup] section**

The TZTBBX will automatically detect engines and tanks connected to the same network.

This is the recommended method for setting up engines and tanks.

#### **[Engine & Tank Manual Setup] section**

The manual set up method should only be used if the automatic setup did not correctly detect your engines or tanks.

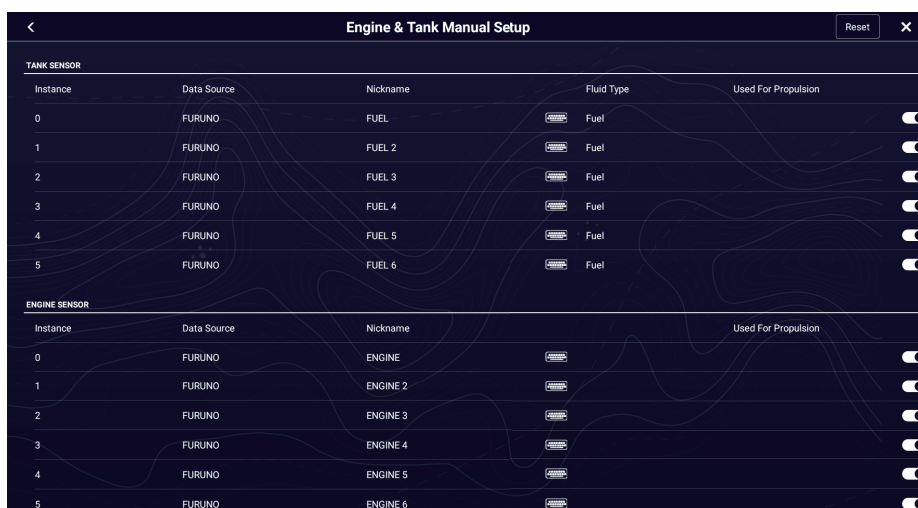

Menu Item	Description	Options (setting range)
[Nickname]	Change the nickname for the engine or tank.	
[Used For Propulsion]	Select which engine/tank is used to calculate the distance which may be traveled using the remaining fuel. [On] uses the engine/tank for calculations, [Off] ignores the engine/tank.	Off, On

Menu Item	Description	Options (setting range)
[Reset]	Resets the engine/tank details to default.	

**[Graphic Instruments Setup] section**

Menu Item	Description	Options (setting range)
[Maximum Boat Speed]	Set the transducer's maximum detectable speed.	1 (kn) to 99 (kn)
[Maximum Wind Speed]	Set the transducer's maximum detectable speed.	1 (kn) to 99 (kn)

*[Graphic Instruments Setup] - [Depth]*

Menu Item	Description	Options (setting range)
[Minimum Depth]	Set the transducer's minimum detectable depth.	1 (m) to 1999 (m)
[Maximum Depth]	Set the transducer's maximum detectable depth.	1 (m) to 2000 (m)

*[Graphic Instruments Setup] - [Sea Surface Temperature]*



Menu Item	Description	Options (setting range)
[Minimum Sea Surface Temperature]	Set the transducer's minimum detectable temperature.	0.00°C to 98.99°C
[Maximum Sea Surface Temperature]	Set the transducer's maximum detectable temperature.	0.01°C to 99.99°C

*[Graphic Instruments Setup] - [Propulsion Engine] or [Other Engine]*

Menu Item	Description	Options (setting range)
[Max. RPM]	Set the maximum rpm of your engine to show on the RPM display.	1 (rpm) to 20,000 (rpm)
[Red Zone Oil Pressure]	Set the starting value for the red zone area of the oil pressure meter.	0 (psi) to 143 (psi)
[Max. Oil Pressure]	Set the maximum oil pressure of your engine.	1 (psi) to 144 (psi)
[Min. Temperature]	Set the minimum temperature for your engine.	0.00°C to 99.00°C
[Red Zone Temperature]	Set the starting value for the red zone area of the engine temperature indicator.	0.01°C to 999.00°C

### 3. HOW TO SET UP THE EQUIPMENT

#### [Graphic Instruments Setup]-[CZone Setup]

Menu item	Description	
[Add Default CZone Pages]	Create, edit C-Zone pages.	
[CZone DIP Switch Settings]	Set this unit's DIP switches. For the service technician. Do not change the settings.	
[Instruments Theme]	Select the graphic theme for the instrument page. Display examples: [Instruments Theme] = [Modern]  Display examples: [Instruments Theme] = [Legacy] 	
[Reset Instrument Pages]	Resets all instrument pages to default.	[OK], [Cancel]
[Reset Default Page Settings]	Resets applicable settings to default.	[OK], [Cancel]

#### [Switching] section

TZTBBX enables power on/off control of digitally controllable devices (such as navigation lights and cabin lights) connected to the NMEA 2000 network. Switches can be displayed on the Instrument display and in a data box.

**Note:** To change the settings for each switch, tap the switch name you want to configure to access the [Switch Configuration] menu.

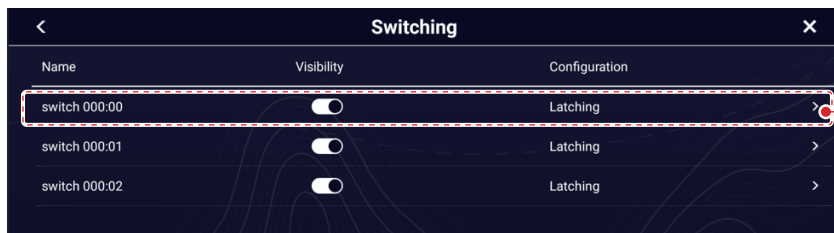

Tap the switch name you want to configure.

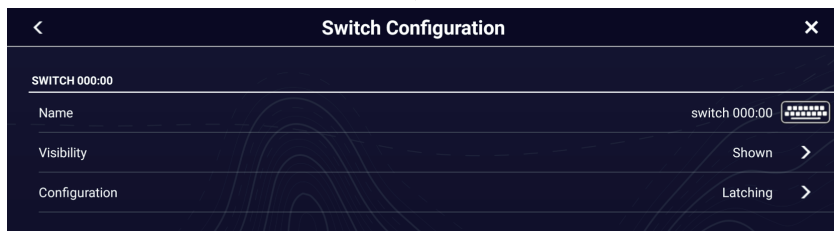

[Switching]-[Switch Configuration]

Menu item	Description	
[Name]	Set the name of the switch. When you tap [Name], software keyboard appears.	
[Visibility]	Choose whether to display the switch on the Instrument display or not. <b>Note:</b> The Show/Hide setting can also be changed using the ON/OFF icon (  ) in the [Switching] window.	[Shown], [Hidden]
[Configuration]	Select the switch type. <ul style="list-style-type: none"> <li>[Latching]: Tap the button once to turn it on or off. The switch changes state each time it is tapped and remains in that state until it is tapped again.</li> <li>[Momentary]: The switch is active only while the button is being tapped. It returns to its original state when released.</li> </ul>	[Latching], [Momentary]

**Note:** When you close the menu, the confirmation message “Create default switches page? Would you like to automatically create a switches instrument page with all detected circuits? You can modify it later.” appears.  
Tap [OK] to enable the display of digital switches on the Instrument display and in a data box.

### 3.5 How to Set Up the Radar (For the service technician only)

#### 3.5.1 Radar source setting

1. Tap the [FURUNO] icon (  ) to show the home screen and display mode settings.
2. Tap [Settings], then tap [Radar].
3. Tap [User Settings] → [Radar Source], then select the appropriate radar sensor.  
**Note:** If a DRS sensor is connected but does not appear in the [Radar Source] list, close the list and open it again. The name of the DRS sensor should appear with a check mark, as in the example below.

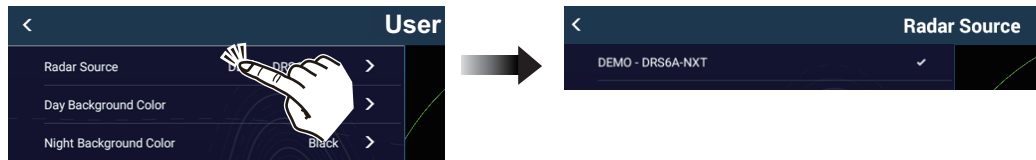

### 3. HOW TO SET UP THE EQUIPMENT

#### 3.5.2 [Radar Initial Setup] menu

1. Tap the [FURUNO] icon (  ) to show the home screen and display mode settings.
2. Tap [Settings], then tap [Radar].
3. Tap [Radar Initial Setup].
4. Referring to the tables which follow, set up the radar.

##### *[Radar] - [Radar Initial Setup] menu*

Menu item	Description	Options (setting range)
[Own Ship Icon]	Show or hide the own ship icon on the radar display.	Off, On
[Bearing Scale Mode]	Select the bearing scale mode. There are two types of mode: true and relative. The behavior changes depending on the orientation mode. <u>Head up mode</u> <ul style="list-style-type: none"> <li>• [Relative]: Bearing scale is fixed and "0°" is at the top of the screen.</li> <li>• [True]: The own ship icon remains fixed and the bearing scale rotates according to the movement of your ship.</li> </ul> <u>North up mode</u> <ul style="list-style-type: none"> <li>• [Relative]: Bearing scale rotates according to the movement of your ship.</li> <li>• [True]: Bearing scale is fixed and "0°" is at the top of the screen.</li> </ul>	[True], [Relative]
[EBL Reference]	You can select the EBL reference from [True] or [Relative]. [True] means the bearing is in reference to the north. [Relative] means the bearing is relative to the heading of your ship. True bearing requires a heading sensor.	[True], [Relative]
[Antenna Rotation]	Select the speed of antenna rotation. Not available (greyed out) with the radar sensor DRS4DL+.	[Auto], [24 RPM]
[Antenna Heading Align]	See section 3.5.3.	-179.9° to +180.0°
[Main Bang Suppression]	If main bang appears at the screen center, slide the circle icon so that the main bang disappears, while watching the radar echo at the left-hand side of the display.	0 to 100
[Enable Sector Blanking]	Up to two sectors may be selected for blanking (no transmission). Select [ON] to enable this feature. Set the start and end angles (0° to 359°).	On, Off
[Enable Sector 2 Blanking]		
[Position from Bow]	Referring to the figure on the right, enter the radar antenna positioning bow-stern (Longitudinal) and port-starboard (Lateral) position from the origin. 	0 m to 999 m
[Position from Port]		-99 m to +99 m Port-side is negative, Starboard-side is positive.
[Height from Surface]	Select the height of the antenna above the waterline. Not available (greyed out) with the radar sensor DRS4DL+.	[Under 3m], [3m-10m], [Over 10m]

Menu item	Description	Options (setting range)
[Antenna Length]	Set the antenna radiator length. Not available (greyed out) with the radar sensor DRS4DL+, DRS2D-NXT, DRS4D-NXT, DRS4D X-Class, DRS4DL X-Class.	[1.0 m], [1.2 m], [1.8 m]
[Auto Tuning]	Enable/disable auto tuning for the connected radar. Not available (greyed out) with the radar sensor DRS2D-NXT, DRS4D-NXT, DRS6A-NXT, DRS12A-NXT, DRS25A-NXT.	Off, On
[Tuning Source]	Select a display in the dual range display to manually tune. Not available (greyed out) with the radar sensor DRS4DL+, DRS2D-NXT, DRS4D-NXT, DRS6A-NXT, DRS12A-NXT, DRS25A-NXT.	[Range1], [Range2]
[Manual Tuning]	Manually tune the radar.	-50 to 50
[Radar Monitoring]	Display various information regarding the connected radar.	
[Radar Optimization]	Automatically adjust magnetron output and tuning for the connected radar. Available when the [TX/STBY] setting is [ON]. Do not change these settings. Not available (greyed out) with the radar sensor DRS2D-NXT, DRS4D-NXT, DRS6A-NXT, DRS12A-NXT and DRS25A-NXT. <b>Note 1:</b> For the service technician only. <b>Note 2:</b> The service technician performs this whenever the magnetron is replaced.	
[ARPA Advanced Settings]	For service technician only. Do not change these settings. This item is available when [TX/STBY] is [ON]. Not available (greyed out) with FAR-2xx8 series, FAR-2xx7 series and FAR-15x8 series radar antennas.	
[TX Channel]	Select [1], [2] or [3], the channel where the interference is smallest. See the operator's manual for details. Available with the radar sensor DRS2D-NXT, DRS4D-NXT, DRS6A-NXT, DRS12A-NXT and DRS25A-NXT.	[Auto], [1], [2], [3]
[Auto acquire by Doppler]	When selecting [ON], approaching targets (ships, rain clutter, etc.) within 3 NM from own ship are automatically acquired by the Doppler calculated from the radar echo. See the operator's manual for details. Available with the radar sensor DRS2D-NXT, DRS4D-NXT, DRS6A-NXT, DRS12A-NXT and DRS25A-NXT.	Off, On
[Reset Default Page Settings]	Resets [Radar Initial Setup] menu settings to default.	[OK], [Cancel]

### 3. HOW TO SET UP THE EQUIPMENT

#### 3.5.3 How to align the antenna heading

You have mounted the antenna unit facing straight ahead in the direction of the bow. Therefore, a small but conspicuous target dead ahead visually should appear on the heading line (zero degrees). In practice, you will probably observe some small bearing error on the display because of the difficulty in achieving accurate initial positioning of the antenna unit. The following adjustment will compensate for the error.

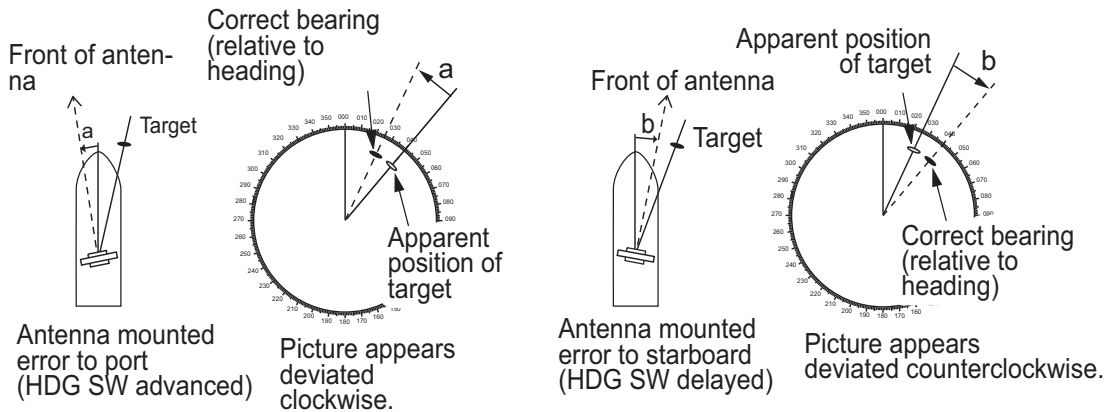

1. Set your radar with 0.125 and 0.25 nm range and the head up mode. You can select a range by using the pinch action. The range appears at the bottom right of the screen. Range may also be selected using the slide bar displayed on the right-hand side of the radar display area. Drag the bar up to zoom in, or down to zoom out.

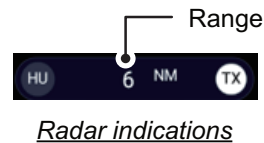
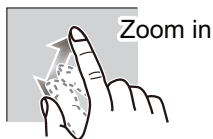

2. Turn the vessel's bow toward a target.
3. Tap the [FURUNO] icon (  ) to show the home screen and display mode settings.
4. Tap [Radar] to show the [Radar] menu.
5. Tap [Radar Initial Setup] → [Antenna Heading Align].
6. Key in an offset value (setting range:  $-179.9^{\circ}$  to  $+180^{\circ}$ ) that puts the target at the very top of the screen, then tap the  $\checkmark$  icon.
  - + : rotate echo in clockwise direction
  - : rotate echo in counterclockwise direction
7. Confirm that the target echo is displayed at correct bearing on the screen.

## 3.6 How to Set Up the Fish Finder

When using the built-in fish finder of the NavNet TZtouch series unit in the same network, or connecting a network sounder (BBDS1 or DFF series), set up the fish finder/sounder as shown in this section.

### 3.6.1 Fish finder source setting

1. Tap the [FURUNO] icon (  ) to show the home screen and display mode settings.
2. Tap [Settings], then tap [Fish Finder].
3. Tap [User Settings] → [Fish Finder Source], then select the fish finder to use. Select from a network fish finder (BBDS1, DFF1, DFF3, DFF1-UHD, DFF3-UHD, DFF1UHD+) or a built-in fish finder of NavNet TZtouchXL series unit in the same network. Setting options for this menu item depend on the equipment connected to this unit.

### 3.6.2 [Fish Finder Initial Setup] menu

1. Tap the [FURUNO] icon (  ) to show the home screen and display mode settings.
2. Tap [Settings] → [Fish Finder] → [Fish Finder Initial Setup].
3. Refer to the table below to set up the fish finder.

**Note 1:** Some menu items are restricted to certain external depth sounders and some menu items may not be available when using the internal depth sounder.

**Note 2:** For DFF-3D setup instructions, see the DFF-3D operator's manual.

*[Fish Finder] - [Fish Finder Initial Setup] menu*

Menu item	Description	Options (setting range)
[Transducer Setup]	Setup Transducer and Motion Sensor. See section 3.6.3 and section 3.6.4.	
[Preset Frequency Setup]	Set to change the TX center frequency and CHIRP width. Please refer to the instruction manual for details. <b>Note:</b> This menu is available when the fish finder source is as follows. <ul style="list-style-type: none"> <li>• Network fish finder DFF3-UHD/DFF1UHD+ (DFF3-UHD program version: 0252480-02.04 or later, DFF1UHD+ program version: 0252495-25.21 or later).</li> <li>• Network-installed NavNet TZtouch3 with DI-FFAMP (TZT9F not included).</li> <li>• NavNet TZtouch3 with CHIRP transducer, or NavNet TZtouchXL (TZT10X/13X/16X).</li> </ul>	[Preset Frequency 1 Setup], [Preset Frequency 2 Setup], [Preset Frequency 3 Setup]

### 3. HOW TO SET UP THE EQUIPMENT

Menu item	Description	Options (setting range)
[Zero Line Rejection]	When you turn the zero line (transmission line) rejection on, the line is not shown, which allows you to see fish echoes near the surface. The width of the line changes with the transducer used and installation characteristics. If the width of the line is 1.4 m or more, set the [Zero Line Range] to higher than 1.4. <b>Note:</b> When any of the models listed below are set as the [Fish Finder Source], and this menu item is set to [ON], set the [Zero Line Range] as shown below. <ul style="list-style-type: none"> <li>• DFF3 • DFF3-UHD • DFF1UHD+</li> <li>• DI-FFAMP (TZT12F/19F/19F)</li> <li>• TZTXFF (built-in fish finder of TZT10X/13X/16X)</li> </ul>	[OFF], [ON]
[Zero Line Range]	When [Zero Line Rejection] is on, you can set the removal range for the zero line. Available when DFF3, DFF3-UHD, DFF1UHD+, TZTXFF (built-in fish finder of TZT10X/13X/16X), or DI-FFAMP (TZT12F/16F/19F) is selected as the fish finder source. If the zero line trail is long, set the value to a larger number. If the line still does not disappear, reduce the transmission power. The default setting is 2.0.	DFF3: 1.4 to 2.5 Other than DFF3: 1.4 to 3.8
[Transducer Draft]	Set the distance between the transducer and the draft line to show the distance from the sea surface.	0.0m to 99.9m
[Salt Water]	Select [ON] if you use this equipment in salt water.	Off, On
[Transmission Format]	Select whether to transmit high and low frequencies simultaneously, or separately with a time delay. Normally, use [Parallel], which transmits the frequencies simultaneously. If you encounter interference near the bottom, select [Sequential A] or [Sequential B] in order to suppress the interference. <b>Note:</b> Shown with connection of DFF3-UHD.	[Parallel], [Sequential A], [Sequential B]
[Transmission Power Mode]	Set the TX power level. See the operator's manual for details.	DFF1-UHD/ DFF1UHD+: [Off], [Min], [Auto] DFF3-UHD: 0 to 10
[External KP]	Select on to synchronize with external sounder's keying pulse.	Off, On
[Bottom Level HF] [Bottom Level MF] [Bottom Level LF]	The default bottom level setting (0) determines that two strong echoes received in sequence are bottom echoes. If the depth indication is not stable in the default setting, adjust the bottom level here. If vertical lines appear from the bottom echo in the bottom lock display, lower the bottom level to erase the vertical lines. If you can not identify the fish near the bottom from the bottom echo, increase the bottom level.	-40 to +40
[Auto Gain Offset HF] [Auto Gain Offset MF] [Auto Gain Offset LF]	If the auto gain offset is wrong, or there is a difference in the gain between the low and high frequencies, set an offset here to balance auto gain for the two frequencies.	-5 to +5

Menu item	Description	Options (setting range)
[STC HF] [STC MF] [STC LF]	Adjust the low (LF), middle (MF) or high (HF) STC frequency. See the operator's manual for details. <b>Note:</b> Available with DFF3, DFF1-UHD, DFF1UHD+, DFF3-UHD, DI-FFAMP (TZT12F/16F/19F).	0 to +10
[TX Pulse HF] [TX Pulse MF] [TX Pulse LF]	The pulse length is automatically set according to range and shift, however it can also be set manually. Use a short pulse for better resolution and a long pulse when detection range is important. To improve resolution on zoom displays, use [Short 1] or [Short 2]. <ul style="list-style-type: none"> <li>[Short 1] improves the detection resolution, but the detection range is shorter than with [Std] (pulse length is 1/4 of [Std]).</li> <li>[Short 2] raises the detection resolution, however detection range is shorter (pulse length is about 1/2 of [Std]) than [Std].</li> <li>[Std] is the standard pulse length, and is suitable for general use.</li> <li>[Long] increases the detection range but lowers the resolution (about 1/2 compared to the [Std] pulse length)</li> </ul> <b>Note:</b> Available with DFF3, DFF3-UHD, or when a narrow-band transducer is used with DI-FFAMP (TZT12F/16F/19F).	[Short1], [Short2], [Standard], [Long]
[RX Band HF] [RX Band MF] [RX Band LF]	Set the bandwidth for low (LF) or high (HF) frequency. The RX bandwidth is automatically set according to pulse length. To decrease noise, select [Narrow]. For better resolution, select [Wide]. <b>Note:</b> Shown with connection of DFF3, DFF3-UHD.	[Narrow], [Standard], [Wide]
[Temperature Port]	Set the data source for water temperature. <ul style="list-style-type: none"> <li>[MJ]: Use the temperature/speed sensor for data.</li> <li>[Low Frequency]: Use the LF sensor for data.</li> <li>[High Frequency]: Use the HF sensor for data.</li> </ul> <b>Note:</b> Shown with connection of DFF3, DFF1-UHD, DFF1UHD+.	[MJ], [Low Frequency], [High Frequency]
[Restore Default Page Settings]	Restore the [Fish Finder Initial Setup] menu settings to default.	[OK], [Cancel]

### 3.6.3 [Transducer Setup] menu

For motion sensor related settings, see section 3.6.4.

**Note:** Make sure that the unit is set to stand-by when setting up the transducer.

Menu item	Description	Options (setting range)
[Transducer Setup Type]	Select the type of transducer connected. When the connected sounder is a DFF1-UHD/ DFF1UHD+ and the transducer has a compatible TDID, [TDID] is automatically selected. <b>Note:</b> When the transducer model is changed or TDID is detected, the frequency and bandwidth set on [Manual] is to be reset. <ul style="list-style-type: none"> <li>[Manual]: Manually set up the transducer.</li> <li>[Model]: Select the appropriate transducer model (for FURUNO or AIRMAR transducers).</li> </ul>	[Manual], [Model]

### 3. HOW TO SET UP THE EQUIPMENT

Menu item	Description	Options (setting range)
[Model Number]	Select the appropriate model number from the list. <b>Note:</b> Only available when [Transducer Setup Type] is set to [Model].	
[High Frequency Min]*	Display the high frequency minimum.	
[High Frequency Max]*	Display the high frequency maximum.	
[Low Frequency Min]*	Display the low frequency minimum.	
[Low Frequency Max]*	Display the low frequency maximum.	
[Reset Default Page Settings]	Reset the [Transducer Setup] menu settings to default.	[OK], [Cancel]

\*: Shown with connection of DFF3.

#### When [Transducer Setup Type] is set to [Model] and connected to DFF3

Menu item	Description
[High Frequency]	Set the frequency (kHz) of the connected high frequency transducer.
[Frequency Adjust HF]	Fine-tune the high-frequency TX frequency to eliminate interference (setting range: -50 to +50). Set to [0] where there is no interference.
[Low Frequency]	Set the frequency (kHz) of the connected low frequency transducer.
[Frequency Adjust LF]	Fine-tune the low frequency TX frequency to eliminate interference (setting range: -50 to +50). Set to [0] where there is no interference.

#### When [Transducer Setup Type] is set to [Model] and connected to DFF3-UHD

Menu item	Description	Options (setting range)
[TX Mode HF]	Band adjustment mode for center frequency and CHIRP frequency of the transducer connected to the high frequency side.	[Auto CHIRP], [FM (Manual CHIRP)], [CW (Fixed Frequency)]
[High Frequency]	Set the high frequency (kHz) of the transducer connected to the high frequency side.	
[Frequency Adjust HF]	If [FM (Manual CHIRP)] or [CW (Fixed Frequency)] is selected at [TX Mode HF], fine-tune the high-frequency TX frequency to eliminate interference (setting range: -50 to +50). Set to [0] where there is no interference.	
[CHIRP Width HF]	If [FM (Manual CHIRP)] is selected in [TX Mode HF], set the CHIRP frequency band of the transducer connected to the high frequency side.	
[TX Mode LF]	Band adjustment mode for center frequency and CHIRP frequency of the transducer connected to the low frequency side.	[Auto CHIRP], [FM (Manual CHIRP)], [CW (Fixed Frequency)]
[Low Frequency]	Set the low frequency (kHz) of the transducer connected to the low frequency side.	
[Frequency Adjust LF]	If [FM (Manual CHIRP)] or [CW (Fixed Frequency)] is selected at [TX Mode LF], fine-tune the low-frequency TX frequency to eliminate interference (setting range: -50 to +50). Set to [0] where there is no interference.	
[CHIRP Width LF]	If [FM (Manual CHIRP)] is selected in [TX Mode LF], set the CHIRP frequency band of the transducer connected to the low frequency side.	

*When [Transducer Setup Type] is set to [Manual]*

Menu item	Description	Options (setting range)
[High Frequency]	Set the kHz frequency for high frequency. Setting ranges vary depending on the transducer connected. <b>Note:</b> Shown with connection of DFF1, BBDS1, DFF3, DFF1-UHD, DFF1UHD+.	
[Transducer Power HF]	Set the transmission power for high frequency. <b>Note 1:</b> Shown with connection of DFF1, BBDS1, DI-FFAMP (TZT12F/16F/19F) or DFF3-UHD. <b>Note 2:</b> For DFF1-UHD or DFF1UHD+ users, when the connected transducer TDID is not supported by the DFF1-UHD/DFF1UHD+, the setting is fixed as [1000].	[600], [1000]
[Band Width (HF)]	Set the bandwidth for high frequency. <b>Note:</b> Shown with connection of DFF3.	
[Low Frequency]	Set the kHz frequency for low frequency. Setting ranges vary depending on the transducer connected. <b>Note:</b> Shown with connection of DFF1, BBDS1, DFF3, DFF1-UHD, DFF1UHD+.	
[Transducer Power LF]	Set the transmission power for low frequency. <b>Note 1:</b> Shown with connection of DFF1, BBDS1, DI-FFAMP (TZT12F/16F/19F) or DFF3-UHD. <b>Note 2:</b> For DFF1-UHD or DFF1UHD+ users, when the connected transducer TDID is not supported by the DFF1-UHD/DFF1UHD+, the setting is fixed as [1000].	[600], [1000]
[Band Width (LF)]	Set the bandwidth for low frequency. <b>Note:</b> Shown with connection of DFF3.	

*When [Transducer Setup Type] is set to [Manual] and connected to DFF3-UHD*

Menu item	Description
[TX Volt HF]	Set the TX voltage (V) of the transducer connected to the high frequency side.
[TX Volt LF]	Set the TX voltage (V) of the transducer connected to the low frequency side.
[High Frequency]	Set the frequency (kHz) of the transducer connected to the high frequency side.
[Low Frequency]	Set the frequency (kHz) of the transducer connected to the low frequency side.
[TX Power HF]	Set the Power of the transducer connected to the high frequency side.
[TX Power LF]	Set the Power of the transducer connected to the low frequency side.

**3.6.4 [Motion Sensor] menu**

The [Motion Sensor] menu sets up the motion sensor, which provides for stable display of the seabed, schools of fish, etc. in moderate-to-rough seas.

**Note 1:** For connection of NMEA0183 equipment to the TZTBX, ask your FURUNO dealer to set up the equipment.

**Note 2:** To use the heaving function, the following settings are required at the satellite compass. For the setting procedure, see the operator's manual for your satellite compass. Settings for SC-30 are done from the [IF-NMEASC] menu, settings for SCX-20 is done from the [DATA OUT] menu.

### 3. HOW TO SET UP THE EQUIPMENT

	NMEA 0183	NMEA 2000
Sentence	ATT, HVE	
Baud rate	38400BPS	
Cycle	25ms	
PGN		Heave: 65280 Attitude: 127257

The [MOTION SENSOR] menu appears in the [Transducer Setup] menu when the [Heaving Correction] is activated in the [Fish Finder] - [User Settings] menu. If the satellite compass SC-30/33/50/70/110/130 is connected, set the distance between the antenna unit (or sensor) of the satellite compass and transducer (high and low if connected) here.

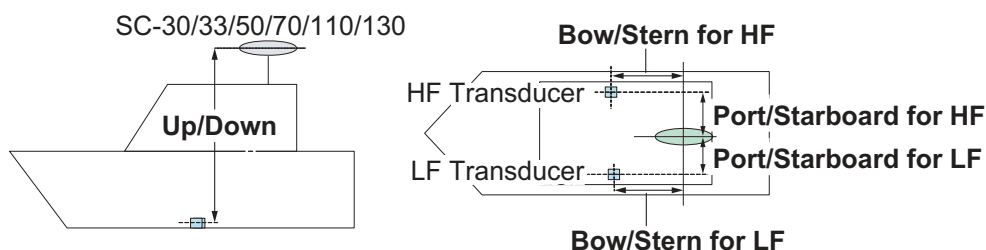

Menu item	Description	Options (setting range)
[Motion Sensor Type]	When the motion sensor is connected through the IF-NMEA2K2, select [NMEA0183]. Otherwise, select [NMEA2000].	[NMEA2000], [NMEA0183]
[Antenna Position Bow/Stern HF (LF)]	Set the distance from the antenna unit to the transducer in the bow-stern direction. If the transducer is located on the fore side, set a positive value.	-99.9 to +99.9
[Antenna Position Up/Down HF (LF)]	Set the distance from the transducer to the antenna unit in the vertical direction. If the transducer is located on the bow side, set a positive value.	0.00 to +99.9
[Antenna Port/Starboard HF (LF)]	Set the distance from the antenna unit to the transducer in the port-starboard direction. If the transducer is located on the starboard side, set a positive value.	-99.9 to +99.9

#### 3.6.5 Transducer mis-mount correction

If the DFF-3D or a CHIRP side scan compatible transducer is installed 180° in reverse (facing stern), turn on the following item:

- DFF-3D: [Settings] → [Multi Beam Sonar] → [Initial Setup] → [Transducer Setup] → [Transducer Mis-mount Correction] → [ON]
- CHIRP Side Scan: [Settings] → [CHIRP Side Scan] → [Transducer Mis-mount Correction] → [ON]

## 3.7 Wireless LAN Setting

### 3.7.1 How to join an existing wireless network

By connecting to an existing network, you may download software updates and weather information from the Internet.

1. Tap the [FURUNO] icon (  ) to show the home screen and display mode settings.
2. Tap [Settings], then [General].
3. Tap [Wireless LAN Settings].
4. Tap [Wireless Mode].
5. Tap [Connect to existing LAN], then tap the [<] icon at the top left of the display.
6. Tap [Wireless] in the [ENABLE WIRELESS] menu.
7. Tap [Scan] to scan the vicinity for accessible WLAN networks. Available networks are listed. To delete all WLAN networks, select [Forget All Available Networks].
8. Tap the appropriate WLAN network to show the following display.

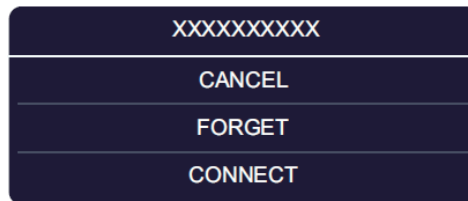

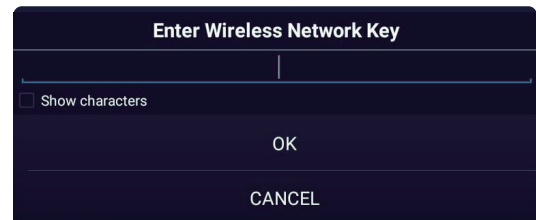

9. Tap [Connect], and the display shown in the right figure appears.
10. Use the software keyboard to enter the network key, then tap the [OK] button. To see what you have input, check [Show characters].
 

**Note:** If the network key is incorrect, an error message appears. Enter the correct key and tap [OK] again.
11. Tap [X] on the title bar to close the menu.



#### 3.7.2 How to create a wireless LAN network

Smart devices connected to this wireless network may also connect directly to the unit, allowing use of the TZTBBX applications.

1. Tap the [FURUNO] icon (  ) to show the home screen and display mode settings.
2. Tap [Settings] then [General], in that order.
3. Tap [Wireless LAN Settings].
4. Tap [Wireless Mode] in the [WIRELESS MODE] menu.
5. Tap [Create Local Network], then tap the [<] icon at the top left of the display.
6. Tap [Name] in the [LOCAL NETWORK SETTINGS] menu.
7. Using the software keyboard, name the unit, then tap the .
8. Tap [Password] in the [LOCAL NETWORK SETTINGS] menu.
9. Using the software keyboard, set the password, then tap the .
10. Tap [Local Network] in the [ENABLE LOCAL NETWORK] menu to activate the wireless network.
11. Your smart device may now be connected to the unit, through the network.
  - 1) From the smart device, select the network set at step 7.
  - 2) Input the password set at step 9.
12. Tap [X] on the title bar to close the menu.

### 3.8 Ferry Mode

**Note:** Only the SC-30, SC-33, and SCX-20 support the Ferry Mode.

The Ferry mode allows the user to rotate the screen orientation by 180°. Note that all the above heading sensors must support heading offset command from the TZTBBX. Both the heading sensor and radar sensor must be powered when the TZTBBX sends the heading offset command to them. If TZTBBX sends the command and one of the sensors does not receive it, the heading data may be reversed. See "[Event Input Configuration]" of "Other menu items" on page 24.

### 3.9 How to Manage Your Charts

A TZ MAPS world chart is provided standard. For all other TZ MAPS charts you will need to purchase and load a chart license (for MM3D paid charts an unlock code is necessary). To share the system ID and unlock code between NavNet TZtouch series units connected within the same network, go the Home page on any unit → [Settings] → [Initial Setup] → turn on [Chart Master].

**Note:** If two or more NavNet TZtouch series devices share an unlock code or license, it is necessary to obtain a new unlock code when changing the Chart Master settings. For example, one unit is set as "main" (Chart master setting: On) and the other unit as "secondary" (Chart master setting: Off), you need to reacquire an unlock code. For information on how to re-obtain the unlock code, see the Operator's Manual.

### 3.9.1 How to update or add TZ MAPS charts

By connecting this device to the Internet and logging into My TimeZero™, you can purchase and renew a TZ MAPS chart license (valid for one year) and download chart data online. Downloaded chart data can be used even when offline by putting it on a microSD card and inserting it into the card slot on the back of the device.

**Note:** Chart licenses are valid for one year, and during this period charts can be downloaded and updated. After the license period expires, you can continue to display the already downloaded charts. However, charts cannot be downloaded or updated. Also, functions that require license cannot be used. After the one-year period you can purchase a new chart license, which will be automatically renewed on a yearly basis. To cancel the automatic renewal, go to your My TimeZero™ account, using the link below. The automatic renewal cannot be canceled from the device side.

<https://extranet.mytimezero.com/>

1. Home page → [Charts] → [TZ MAPS Store].

Tap here to highlight the selected area, on the right side of the screen (White background: Not purchased, Blue background: Purchased).

[Buy]: Not purchased, [ ✓ ]: Purchased

\*: When the license expires (one year), the indication changes to [Subscribe], and when you select and purchase a subscription, the indication changes to [Subscribed].

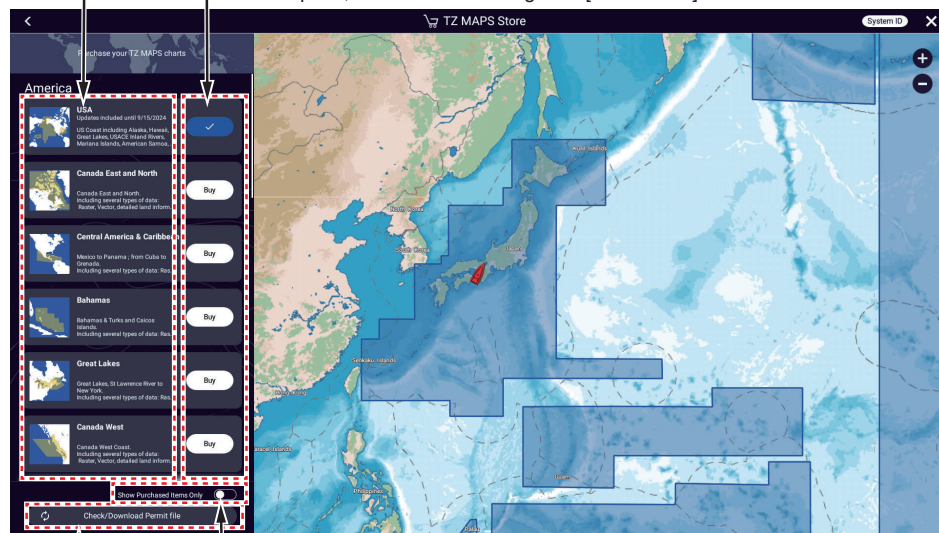

Turn ON to display only purchased charts.

Tap to check whether there is a license for the purchased chart. If there is, the file will be downloaded. After downloading, the [Buy] button of the purchased chart changes to a blue button, and you can then download the chart data for the purchased area ✓.

### 3. HOW TO SET UP THE EQUIPMENT

2. Tap the [Buy] button corresponding to the area to purchase. The message "Please wait, preparing your purchase" appears then the "buy screen" appears.

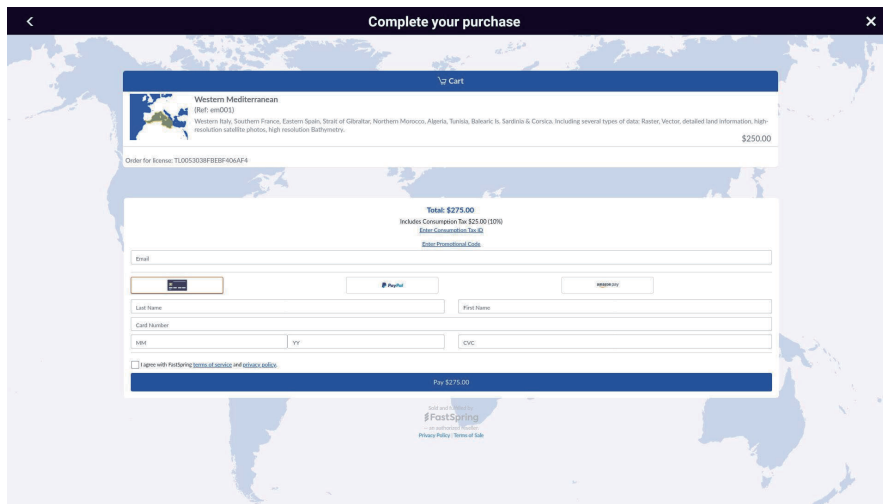

If you are not connected to the Internet, a QR code appears. Use your smartphone/tablet to read it and display the "buy screen".

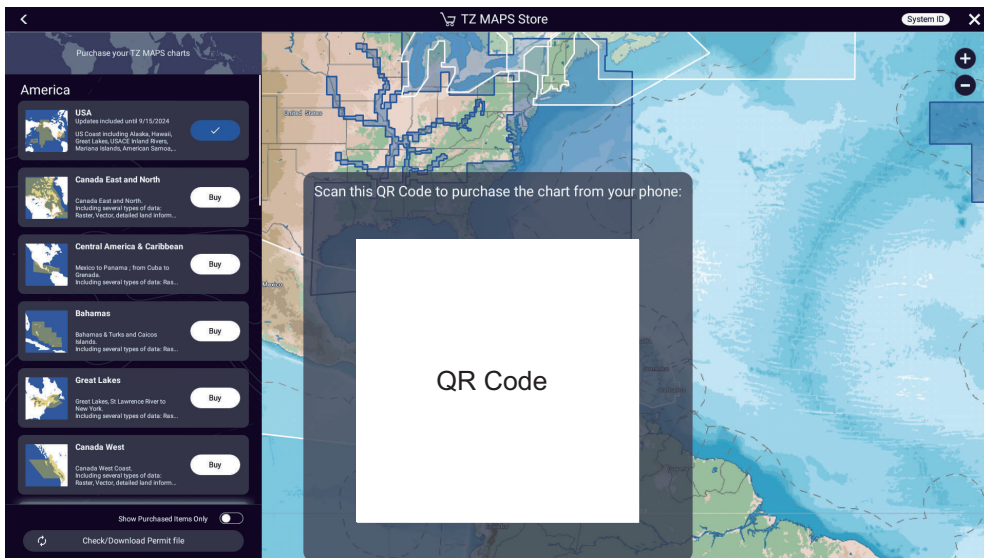

3. Select how to buy the chart.
4. Enter the required information.
5. Read the conditions of purchase, check ✓ to agree, then tap [Payment].
6. If you purchase a license using a QR code, a ZUC file is sent to your registered email address. Save the file to a USB flash memory, insert the memory into the USB port of this equipment, and read the file.

### 3.9.2 How to update TZ MAPS charts

If there is a new version of a downloaded chart data, there are two ways to update the chart, individually or all at once.

1. Home page → Charts] → [TZ MAPS Update].

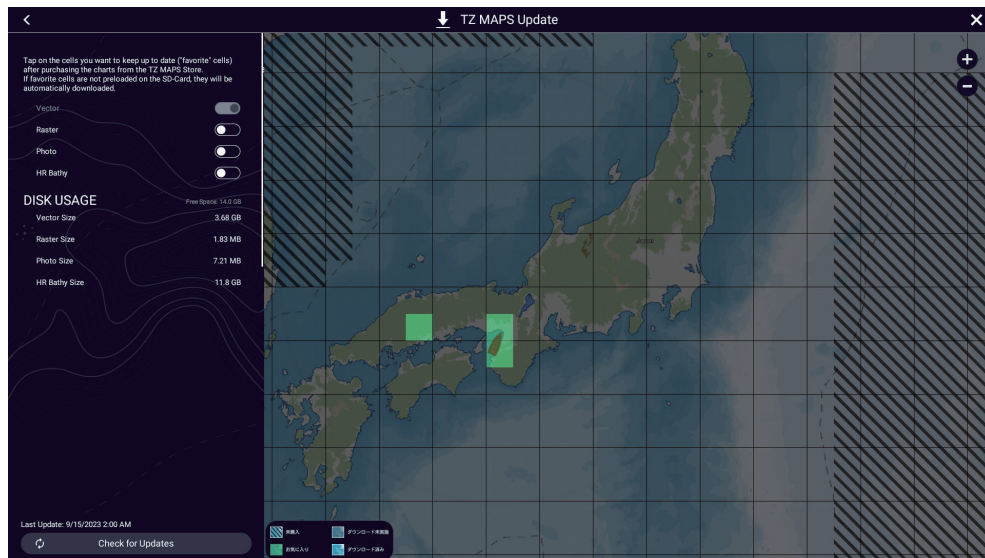

2. **Update chart data individually:** Tap the area you want to update.  
**Update chart data collectively:** Tap [Check for Updates], at the bottom left corner of the screen. A “↓” icon appears in those areas that have [Favorites] status and can be updated. You can update multiple areas. Tap [Download Updates] at the bottom left corner of the screen. The download begins and progress is indicated at the bottom left corner of the screen. The [Download Updates] button changes to [Cancel] and then to [Downloaded] once the download is complete.  
**For individual download,** the selected area is given [Favorites]\* status. Tap [X] on the title bar to close the [TZ MAPS Update] screen and complete the process.



- \*: Depending on the status of chart data, each area is classified and displayed into the following four types. [Favorites] switches between [Favorites] and [Downloaded] each time you tap an area.



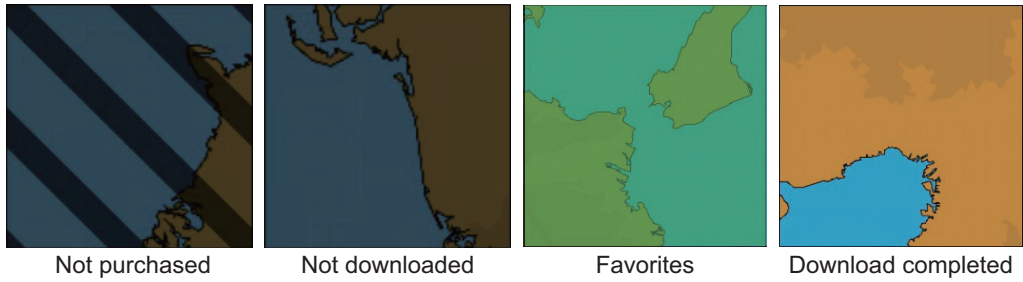

### 3. HOW TO SET UP THE EQUIPMENT

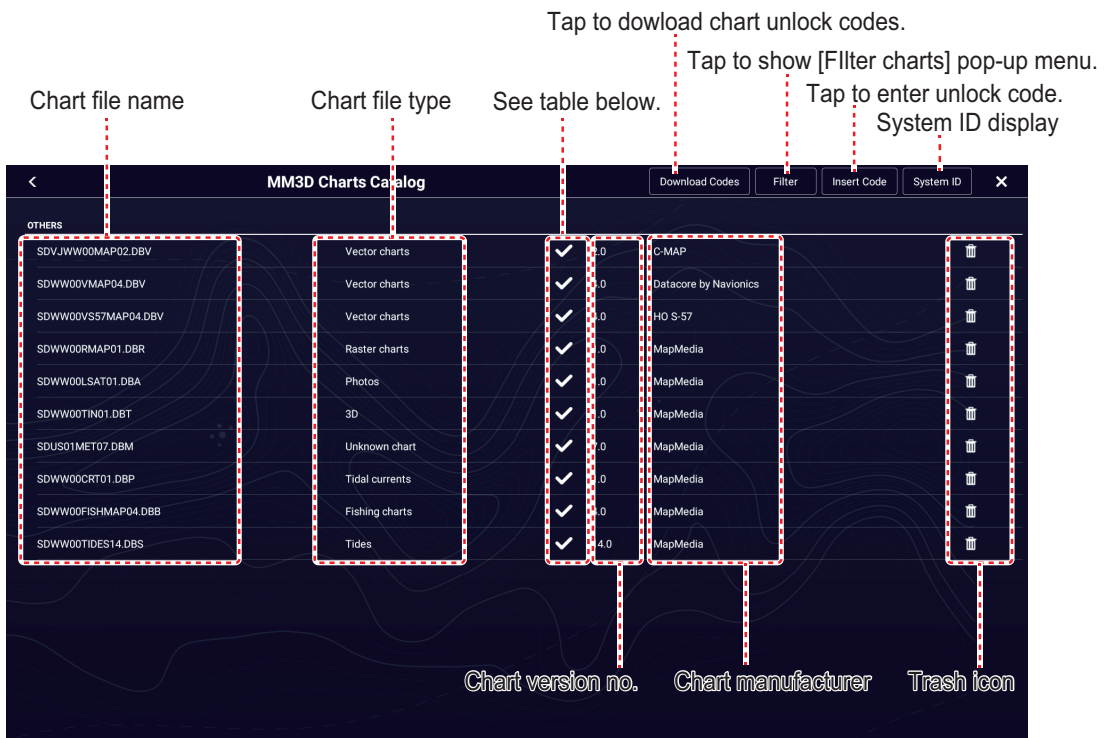

#### 3.9.3 How to display the MM3D charts catalog

The chart catalog shows the MM3D charts, satellite photos, tidal information, etc. incorporated in this equipment. To display the MM3D charts catalog, Home page → [Charts] → [MM3D Charts Catalog].



Chartstatus icon	Meaning	Chartstatus icon	Meaning
	Free chart. An unlock code is not necessary.		Paid chart. Unlock code entered.
	Paid chart. Unlock code is necessary to use the chart. Tap [Insert Code] at the top of the [Charts Catalog] screen. Enter the unlock code then tap [✓] to finish.		Chart cannot be used because it is corrupted.

### **How to hide unnecessary charts on the chart catalog list**

1. Tap [Filter] on the chart catalog list title bar to show the [Filter charts] window.
2. Select [OFF] for the items that you want to hide. The factory setting shows all charts. To restore all charts, tap [Reset Filters].  
**Note:** To restore all items to default (all ON), tap [Reset Filters].
3. Tap [<] on the title bar to return to the chart catalog list. [Filter] on the title bar changes to [Change Filter].
4. Tap [x] to finish and close the chart catalog list.

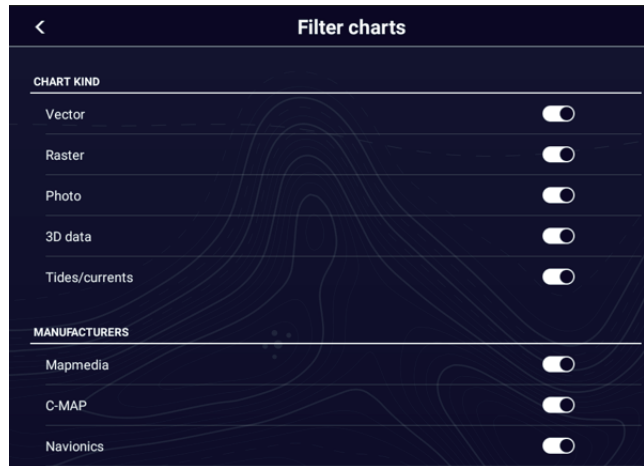

### **3.9.4 How to add MM3D charts**

For information on how to obtain a chart and its unlock code, contact place of purchase or the nearest FURUNO branch or sales office. Put the chart you obtained into a microSD card and insert it into the card slot on the back of the device. If you have added a paid chart, enter the unlock code (see section 3.9.3).

### **3.9.5 How to MM3D charts**

To delete charts, Home page → [Charts] → [MM3D Chart Catalog]. Tap the trash can icon (right edge of screen) corresponding to the chart to delete. You are asked if you are sure to delete the chart. Tap [OK] to delete the chart.

## **3.10 IP Camera Setup**

When connecting one or more IP camera (maximum 8), the following settings are required at the camera.

- IP Address: 172.31.xxx.xxx
- Subnet Mask: 255.255.0.0

## 3.11 How to Set Up the SUZUKI Engine

This section covers the installation settings for your SUZUKI Gateway and SUZUKI engines. For details regarding the SUZUKI engine display, see your Operator's Manual or eGuide.

To open the setting menu for the SUZUKI engine, do as follows:

1. Tap the [FURUNO] icon (  ) to show the home screen.
2. Tap [Settings].
3. Drag the menu to display the [Suzuki Engine Setup] menu, then tap [Suzuki Engine Setup].  
**Note:** The [Suzuki Engine Setup] menu appears when [Suzuki Mode] is set to [ON] on the service menu.
4. Tap [Installation...].  
 A confirmation message appears.
5. Tap the [OK] button to open the [ENGINE INITIAL SETUP] menu, then do the procedures that follow.

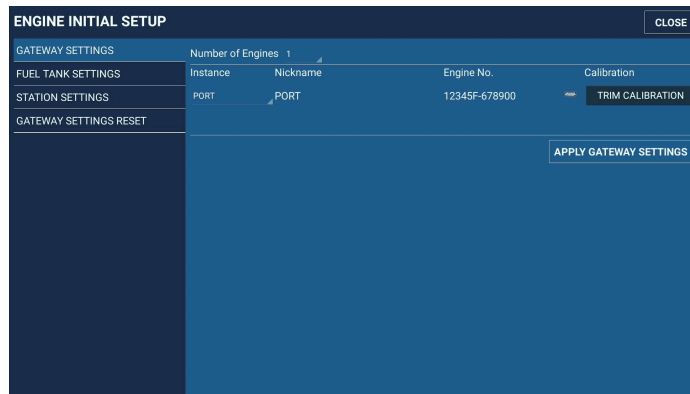

### 3.11.1 Engine installation

Before using the gateway, register the engine position and the engine serial number with gateway as shown below.

#### **Number of engines (ex. Dual Engines Mechanical Remote Control Model )**

1. Tap [GATEWAY SETTINGS].
2. Tap [Number of Engines].

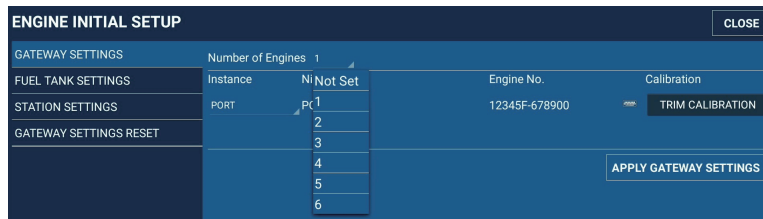

3. Select the number of engines.

### Gateway Setting

1. Tap the [Instance] field of [Instance] for the gateway to be set.

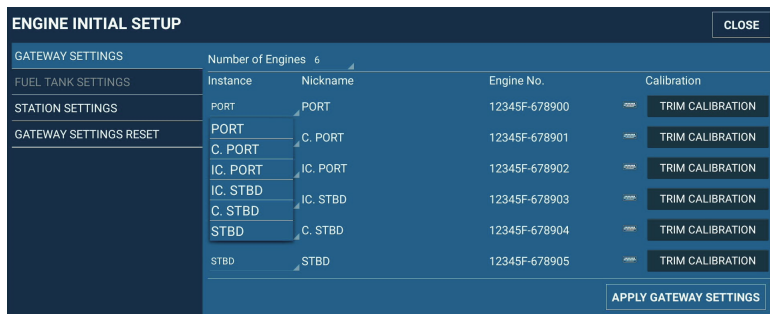

2. Select the engine position.

**Note:** The setting options shown on the drop-down list change depending on the [Number of Engines] setting.

### Engine No.

1. Tap the keyboard icon to the right of the [Engine No.] field for the gateway to be set.



Confirm and apply the value or setting.  
 Cancel input and close the keyboard.  
 Move the cursor left or right.

2. Input the engine number, then tap the [OK] button to apply the setting.

### Trim Calibration (Only Trim Sender Model)

1. Tap the [TRIM CALIBRATION] button to show the following message.

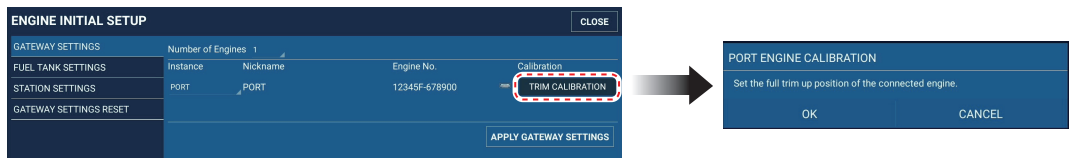

2. Set the full trim up position of the connected engine, then tap the [OK] button. The following message appears.



3. Set the full trim down position of the connected engine, then tap the [OK] button.
4. Tap the [APPLY GATEWAY SETTING] button to apply the settings on the [GATEWAY SETTINGS] menu. The following confirmation message appears.

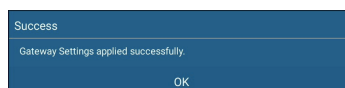

5. Tap the [OK] button to close the confirmation message.

### 3. HOW TO SET UP THE EQUIPMENT

#### **Station Settings**

1. Tap [STATION SETTINGS].
2. Tap [Station Setting].

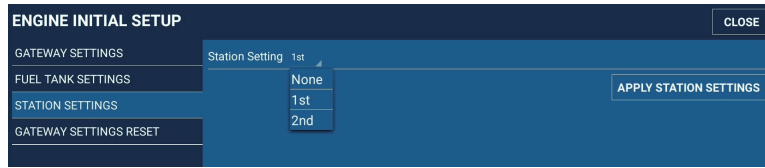

3. Select the station.
4. Tap the [APPLY STATION SETTINGS] button to apply the setting. The following confirmation message appears.

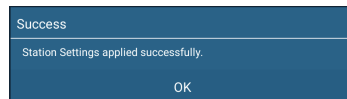

5. Tap the [OK] button to close the message.

#### **Gateway settings reset**

You can clear the followings settings and data for any of the connected Gateways and their connected engines. Typically this is not required unless you have replaced or added a new engine and/or Gateway.

- [Instance]
- [Fuel Economy Average]
- [Engine No.]
- [Engine Trip Time]
- [QR Code]\*
- [Engine Trip Distance]
- [Log data]
- [Total Fuel Used]

\*: QR code is registered trademark of DENSO WAVE INCORPORATED.

1. Tap [GATEWAY SETTING RESET].

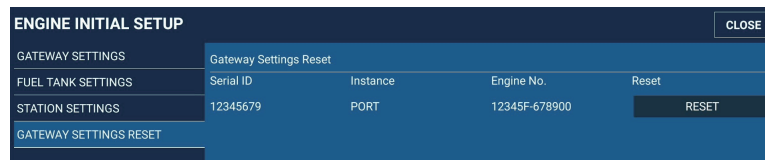

2. Tap the [RESET] button for the gateway to be reset. The following confirmation message appears.

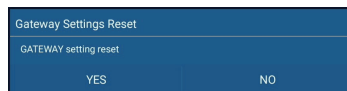

3. If necessary to reset, tap [YES]. If not necessary to reset, tap [NO].

#### **Fuel Adapter Settings**

1. Tap [FUEL TANK SETTINGS].

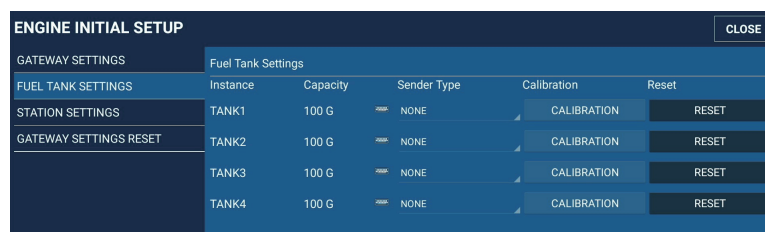

2. Tap the keypad icon to the right of the [Capacity] field for the tank to be set.

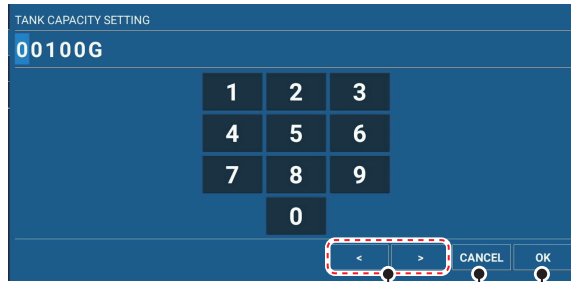

Move the cursor left or right.  
 Cancel input and close the keyboard.  
 Confirm and apply the value or setting.

3. Input the tank capacity, then tap the [OK] button.  
**Note:** Input 9999L or less.

### ABYC & EU & Custom

1. Tap [Sender Type] of the tanks.

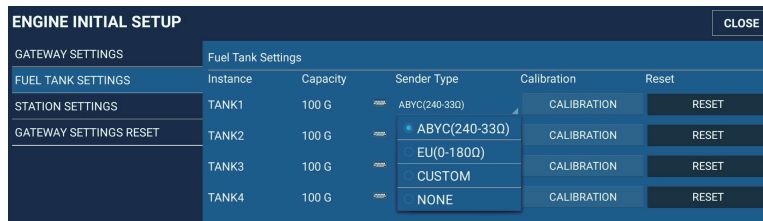

2. Select the sender type.
3. If [CUSTOM] is selected, the [CALIBRATION] button is selectable. Tap the [CALIBRATION] button to show the following message.

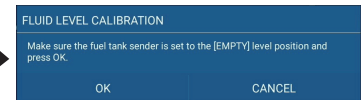
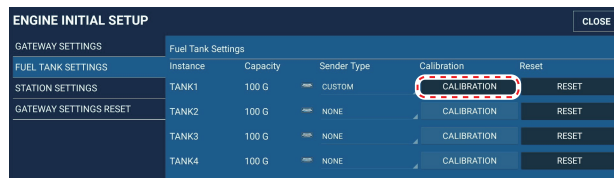

### 3. HOW TO SET UP THE EQUIPMENT

4. Calibrate the fluid level according to the following procedure. Repeat the calibration from EMPTY to FULL.

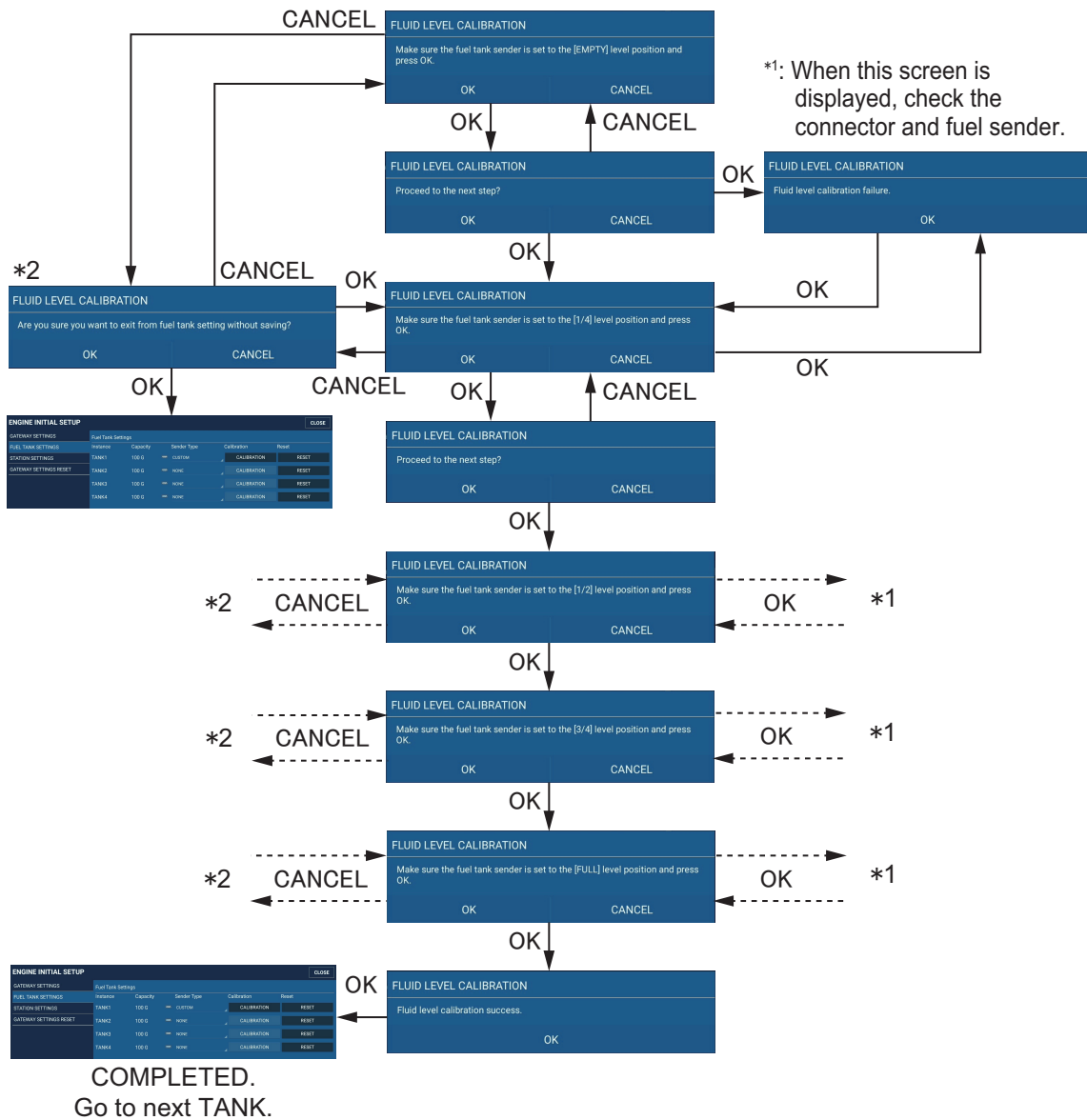

### **Fuel Tank Settings Reset**

You can clear the fuel tank settings and data for any of the connected fuel adapter and their connected engines. Typically this is not required unless you have replaced or added a new engine and/or fuel adapter.

1. Tap the [RESET] button of the fuel tank to be initialized.
2. If necessary to reset, tap [YES]. If not necessary to reset, tap [CANCEL].
3. Initialization completed. Tap the [OK] button and go back to the [Fuel Tank Settings] menu.

# APPX. 1 JIS CABLE GUIDE

Cables listed in the manual are usually shown as Japanese Industrial Standard (JIS). Use the following guide to locate an equivalent cable locally.

JIS cable names may have up to 6 alphabetical characters, followed by a dash and a numerical value (example: DPYC-2.5).

For core types D and T, the numerical designation indicates the *cross-sectional Area (mm<sup>2</sup>)* of the core wire(s) in the cable.

For core types M and TT, the numerical designation indicates the *number of core wires* in the cable.

## 1. Core Type

D: Double core power line

T: Triple core power line

M: Multi core

TT: Twisted pair communications  
(1Q=quad cable)

## 2. Insulation Type

P: Ethylene Propylene Rubber

## 3. Sheath Type

Y: PVC (Vinyl)

## 4. Armor Type

C: Steel

## 5. Sheath Type

Y: Anticorrosive vinyl sheath

## 6. Shielding Type

SLA: All cores in one shield, plastic tape w/aluminum tape

-SLA: Individually shielded cores, plastic tape w/aluminum tape



DPYC



TPYC



MPYC-4



TTYCSLA-4

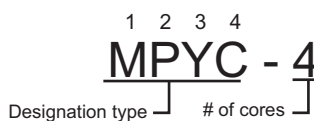
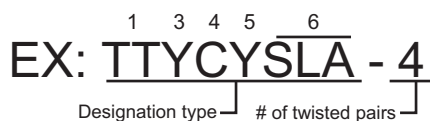

The following reference table lists gives the measurements of JIS cables commonly used with Furuno products:

Type	Core		Cable Diameter	Type	Core		Cable Diameter
	Area	Diameter			Area	Diameter	
DPYC-1.5	1.5mm <sup>2</sup>	1.56mm	11.7mm	TTYCSLA-1	0.75mm <sup>2</sup>	1.11mm	9.4mm
DPYC-2.5	2.5mm <sup>2</sup>	2.01mm	12.8mm	TTYCSLA-1T	0.75mm <sup>2</sup>	1.11mm	10.1mm
DPYC-4	4.0mm <sup>2</sup>	2.55mm	13.9mm	TTYCSLA-1Q	0.75mm <sup>2</sup>	1.11mm	10.8mm
DPYC-6	6.0mm <sup>2</sup>	3.12mm	15.2mm	TTYCSLA-4	0.75mm <sup>2</sup>	1.11mm	15.7mm
DPYC-10	10.0mm <sup>2</sup>	4.05mm	17.1mm	TTYCY-1	0.75mm <sup>2</sup>	1.11mm	11.0mm
DPYCY-1.5	1.5mm <sup>2</sup>	1.56mm	13.7mm	TTYCY-1T	0.75mm <sup>2</sup>	1.11mm	11.7mm
DPYCY-2.5	2.5mm <sup>2</sup>	2.01mm	14.8mm	TTYCY-1Q	0.75mm <sup>2</sup>	1.11mm	12.6mm
DPYCY-4	4.0mm <sup>2</sup>	2.55mm	15.9mm	TTYCY-4	0.75mm <sup>2</sup>	1.11mm	17.7mm
MPYC-2	1.0mm <sup>2</sup>	1.29mm	10.0mm	TTYCY-4SLA	0.75mm <sup>2</sup>	1.11mm	19.5mm
MPYC-4	1.0mm <sup>2</sup>	1.29mm	11.2mm	TTYCYSLA-1	0.75mm <sup>2</sup>	1.11mm	11.2mm
MPYC-7	1.0mm <sup>2</sup>	1.29mm	13.2mm	TTYCYSLA-4	0.75mm <sup>2</sup>	1.11mm	17.9mm
MPYC-12	1.0mm <sup>2</sup>	1.29mm	16.8mm	TTPYCSLA-1	0.75mm <sup>2</sup>	1.11mm	9.2mm
TPYC-1.5	1.5mm <sup>2</sup>	1.56mm	12.5mm	TTPYCSLA-1T	0.75mm <sup>2</sup>	1.11mm	9.8mm
TPYC-2.5	2.5mm <sup>2</sup>	2.01mm	13.5mm	TTPYCSLA-1Q	0.75mm <sup>2</sup>	1.11mm	10.5mm
TPYC-4	4.0mm <sup>2</sup>	2.55mm	14.7mm	TTPYCSLA-4	0.75mm <sup>2</sup>	1.11mm	15.3mm
TPYCY-1.5	1.5mm <sup>2</sup>	1.56mm	14.5mm				
TPYCY-2.5	2.5mm <sup>2</sup>	2.01mm	15.5mm				
TPYCY-4	4.0mm <sup>2</sup>	2.55mm	16.9mm				



# PACKING LIST

19BP-X-9854-3

1/1

TZTBBX-E/-J

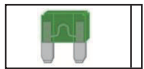
A-1

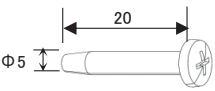
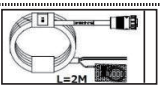
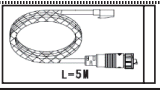
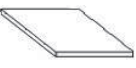
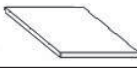
NAME	PRODUCT NAME	OUTLINE	DESCRIPTION/CODE No.	Q'TY
ユニット UNIT				
制御部 Processor UNIT		 310 x 210	TZTBBX-*	1
予備品 SPARE PARTS				
予備品 SPARE PARTS	ヒューズ(5A) FUSE (5A)	 ※電源ケーブルに同梱 Spare fuse included with power cable	FRU-60V-FU-5A	1
付属品 ACCESSORIES				
	SDカード(チャート) MICRO SD CARD	 ※指定部に挿入済 Pre-installed in card slot.	JE07012-C170	1
工事材料 INSTALLATION MATERIALS				
工事材料 INSTALLATION MATERIALS	ネジ袋詰め品 PACKAGED SCREW		JE07012-B369	1
	ネジ(呼び5) SCREW(D5)		JE82001-0015	4
	電源ケーブル POWER CABLE		FRU-3P-FF-A002M-003R	1
	ネットワークケーブル NETWORK CABLE		FRU-RZWPNWP-005G	1
図書 DOCUMENT				
図書 DOCUMENT	装備要領書(和/英) INSTALLATION MANUAL(JP/EN) TZTBBX		IM*-45290-*	1
	操作要領書(和/英) OPERATOR'S GUIDE(JP/EN) TZT10X/13X/16X/22X/24X/BBX		OS*-45240-*	1



19BP-X-9854-3

(略図の寸法は、参考値です。 DIMENSIONS IN DRAWING FOR REFERENCE ONLY.)

JE07012-Y681



表1 TABLE 1

寸法区分 (mm) DIMENSION	公差 (mm) TOLERANCE
L ≤ 50	±1.5
50 < L ≤ 100	±2.5
100 < L ≤ 500	±3

↓  
重力方向  
(壁掛時)  
DOWNWARD  
(BULKHEAD MOUNT)

注 記

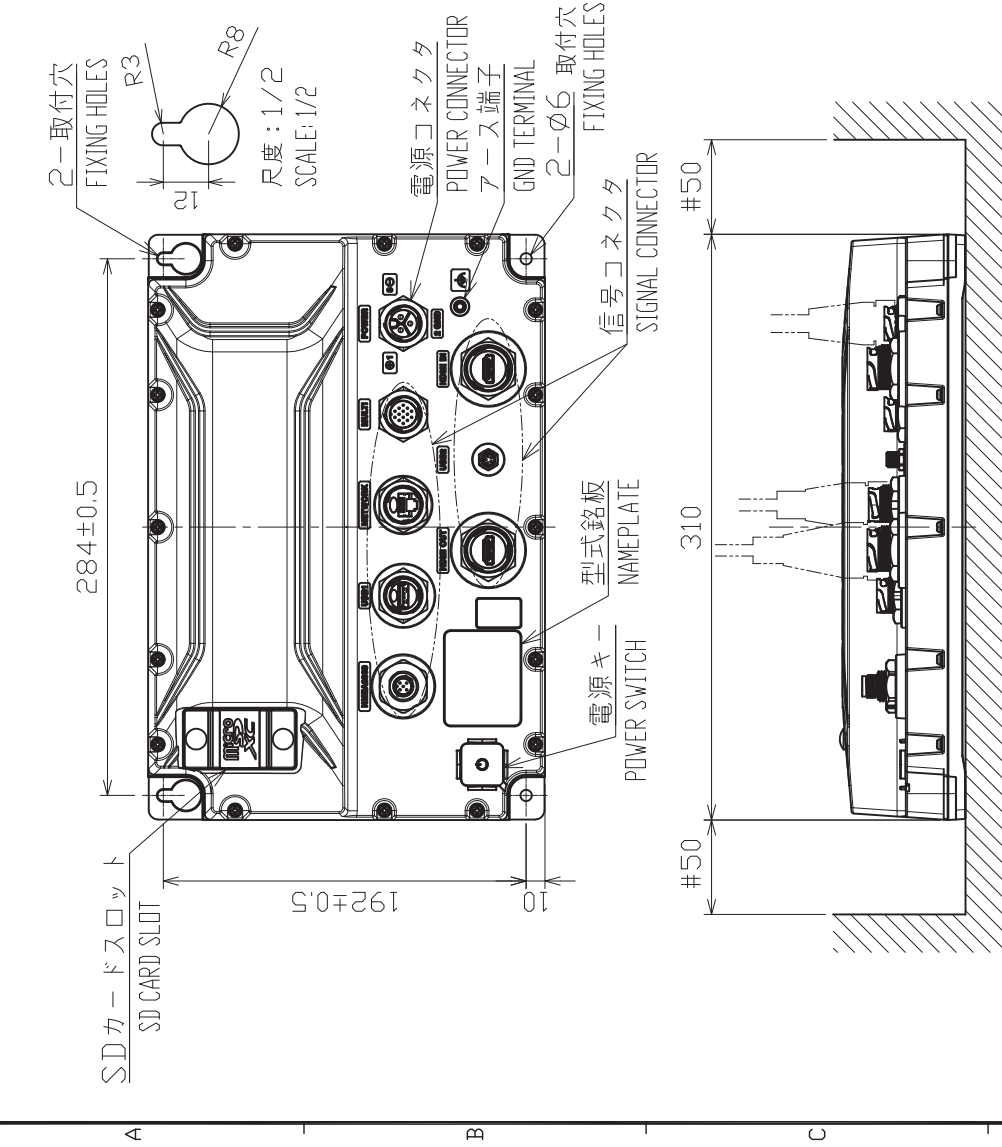
- 1) 指定外の寸法公差は表 1 による。
- 2) # 印寸法は最小サービスマン間寸法とする。
- 3) 取付用ネジはトラスタックピンネジ呼び径 5 x 2.0 を使用のこと。

NOTE

1. TABLE 1 INDICATES TOLERANCE OF DIMENSIONS WHICH IS NOT SPECIFIED.
2. # MINIMUM SERVICE CLEARANCE.
3. USE TAPPING SCREWS  $\phi 5 \times 2.0$  FOR FIXING THE UNIT.

DRAWN	19/Apr/2024	I. YAMASAKI	TITLE	TZTBXB
CHECKED	20/May/2024	A. MURAO	名称	マルチファンクションディスプレイ (壁掛・卓上装備)
APPROVED	20/May/2024	A. MURAO	外寸図	
SCALE	1/4	MASS 1.3 ±0.07 kg	NAME	MULTI FUNCTION DISPLAY (BULKHEAD/TABLETOP MOUNT)
DWG. No.	C4529-001-A	REF. No.	19-036-200G-1	OUTLINE DRAWING



This page is intentionally left blank.

This page is intentionally left blank.



**FURUNO ELECTRIC CO., LTD.**

9-52 Ashihara-cho,  
Nishinomiya, 662-8580, JAPAN

• FURUNO Authorized Distributor/Dealer

All rights reserved. Printed in Japan

Pub. No. IME-45290-E

(MIKU) TZTBBX

A : JUN. 2024  
E : APR. 23, 2026



0 0 0 1 0 1 4 6 9 2 0