

NAVIGATIONAL ECHO SOUNDER



Model:
FE-800

NAVIGATIONAL ECHO SOUNDER



FURUNO Navigational Echo Sounder FE-800 displays the clearance below the ship in the dual frequency operation*

- ▶ **Dual frequency display (50/200 kHz)***
The depth at the FORE and AFT positions can be displayed simultaneously.
- ▶ **A variety of display modes available: NAV, OS DATA and HISTORY**
- ▶ **High contrast 8.4" LCD**
- ▶ **When interfaced with FURUNO remote display RD-20/50, depth information can be observed at a remote location**
- ▶ **Optional printer interface available for printing out echogram**
- ▶ **Connecting a PC with the optional data recording software allows you to store, compile and print out the past data of the echogram via PC**
- ▶ **Meeting requirements for BAM (Bridge Alert Management)**
Meets the specific requirements for alerts and interconnection with Bridge Alert Management in IMO MSC.302 (87)
- ▶ **Depth data for the past 24 hours is storable in the internal memory**
For the amount of data for storage and playback on the FE-800, please refer to "HISTORY" on the right page. With the optional PC software, the sounding information can be stored and played back for 24 hours, when the recording interval is set at 5 sec.

▶ Visual and audible alerts

The FE-800 generates alerts when the water depth below transducer is shallower than a preset depth. When the seabed is lost due to the lowered power supply or out of range scale, an alert is generated.

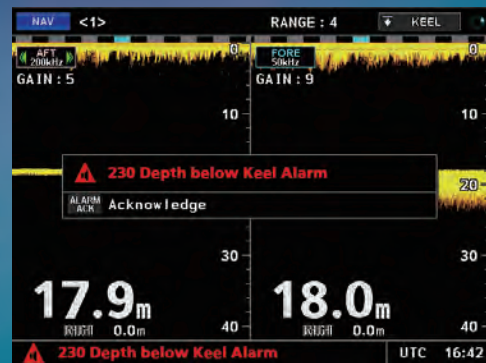

*When interfaced with two transducers

NAV Mode

Displays the depth numerically and graphically.

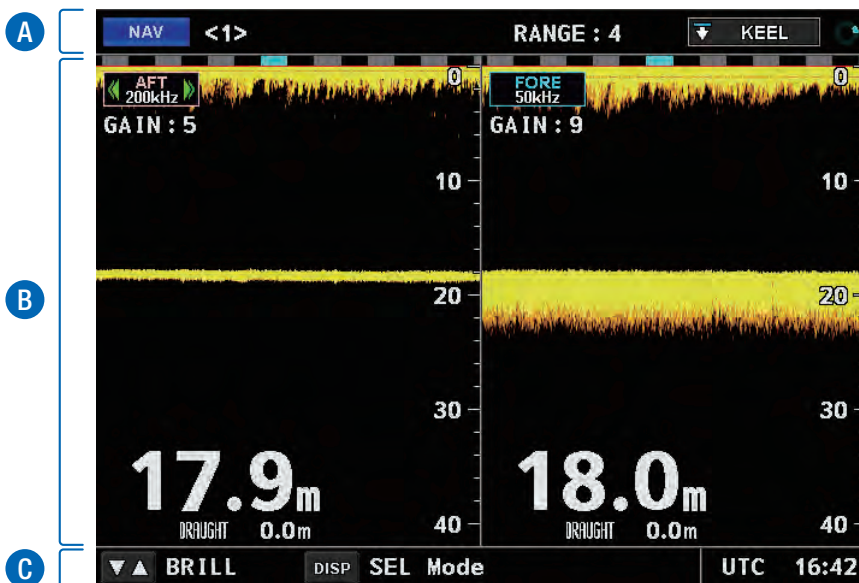

- A** Current range setting, reference point for the depth reading (Transducer/Surface/Keel) as well as currently selected mode are displayed.
- B** This area shows the information specific to the display mode currently selected. Please refer to each of the display modes for details.
- C** Guide to currently available actions is displayed. Under an alert situation, the information about the most imminent alert is displayed.

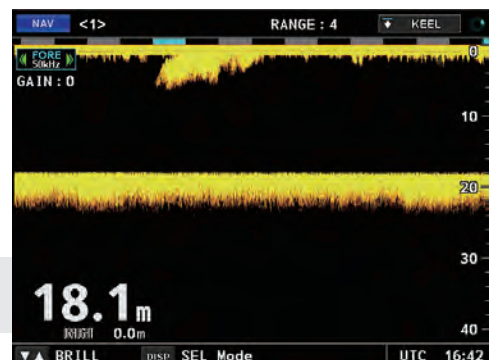

Single frequency display (FORE or AFT) ▶▶

OS DATA

Displays Own Ship Data (OS DATA)*

* only available if the FE-800 is connected to an external EPFS (Electronic Position-Fixing System), such as a GPS navigator.

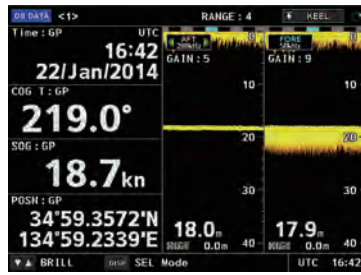

HISTORY

Displays a combination of Contour and Strata echo readings taken.

Recording interval setting	Amount of data for storage and playback
5 sec	1 h
1 min	12 h
2 min	24 h

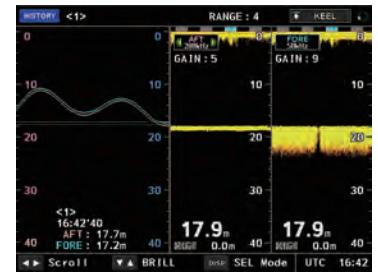

LOGBOOK

Displays the stored time, depth and own ship position. The logbook is capable of storing data for up to 720 log entries.

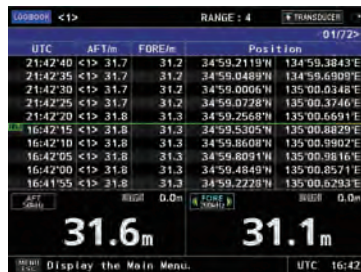

Alert Log List

Displays the alert history (containing up to 100 alerts).

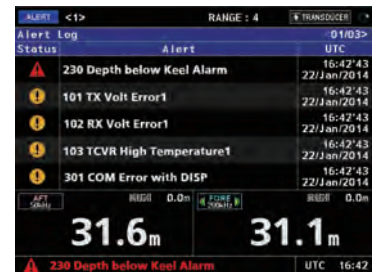

Color Presentation

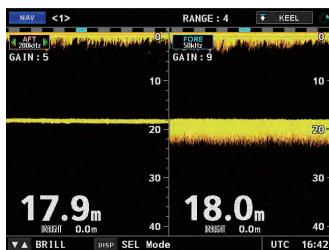

Background: Black Echo: Amber



Background: Black Echo: Red



Background: Blue Echo: Red

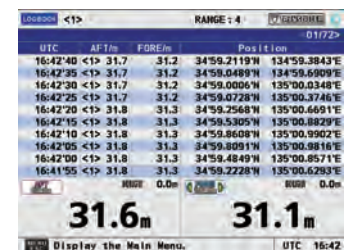

Background: White Text: Black

Optional printer and PC software to utilize the stored data

The past data can be stored on a PC with the optional software. Also, printout function of the echogram is available via the optional printer PP-900.



Printer PP-900

PC software

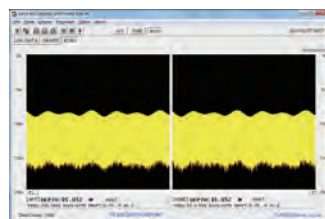

Echo mode

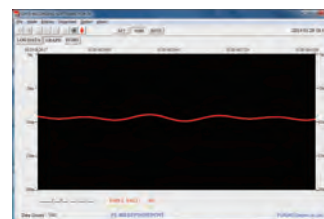

Graph mode

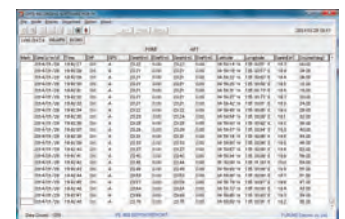

Log mode

Interconnection Diagram

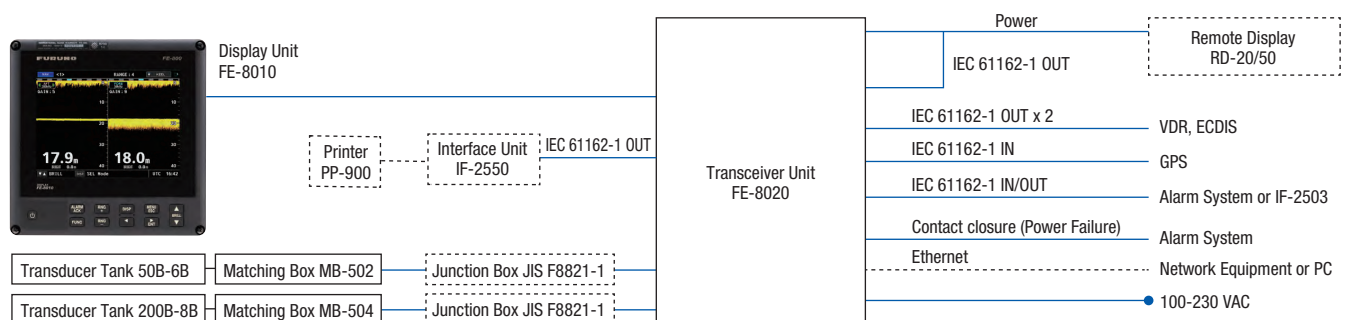

SPECIFICATIONS

Product Name	NAVIGATIONAL ECHO SOUNDER	
Accuracy	0.5 m at 20 m range, 5 m at 200 m range, or 2.5% of depth range	
Roll/Pitch Tolerance	Roll: $\pm 10^\circ$ Pitch: $\pm 5^\circ$	
Discrimination	more than 5 mm per meter depth on 20 m range more than 0.5 mm per meter depth on 200 m range	
Picture Advance Speed	15 minutes at 200 m range	
Output Power	1 kW rms	
Frequency	50 kHz, 200 kHz, 50/50 kHz, 50/200 kHz, 200/200 kHz	
Transducer	50 kHz: 50B-6B 200 kHz: 200B-8B	
Range Scale	8 steps default: 5, 10, 20, 40, 100, 200, 400, 800 m	
Display	8.4" color LCD	
Display Modes	NAV, HISTORY, OS DATA	
Display Colors	Echo: 8 colors Background/Texts: 3 types (Black/White, Blue/White, White/Black)	
Interface	IEC 61162-450 x 1 RS-232C x 1 IF-2550 x 1 (PP-900)	
Input	IEC 61162-1 (IN) x 2	
Output	IEC 61162-1 (OUT) x 4 Contact closure x 1 (Power fail)	
Auto Function	Range, Gain	
Alert	Shallow depth, Power Failure* <small>*At the time of the power failure, FE-800 cannot generate visual/audible alarms. Please interface the equipment which can generate visual/audible alarms to FE-800.</small>	
Data Recording Period	Recording Interval Setting	Amount of Data for Storage and Playback
	5 sec	1 h
	1 min	12 h
	2 min	24 h

POWER SUPPLY

100-230 VAC 1 Φ 50/60 Hz

ENVIRONMENT

Ambient Temperature	Display Unit	-15°C to 55°C
	Transceiver Unit	-15°C to 55°C

Display Unit

FE-8010
2.3 kg 5.1 lb

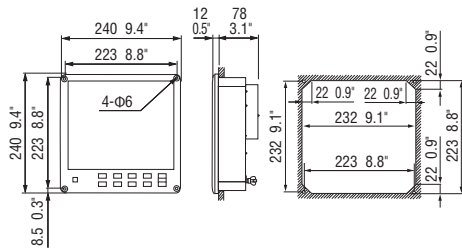

Matching Box

MB-502 (for 50B-6B)
MB-504 (for 200B-8B)
2.6 kg 5.7 lb

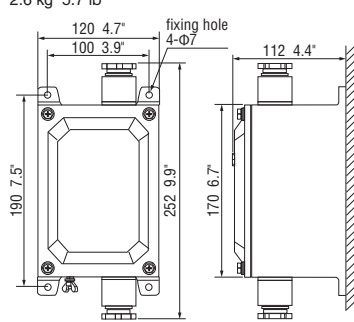

Transducer

50B-6B
4.1 kg 9.0 lb

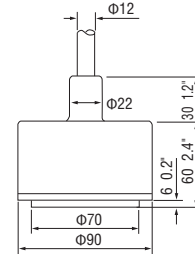

Transducer

200B-8B
3.6 kg 7.9 lb

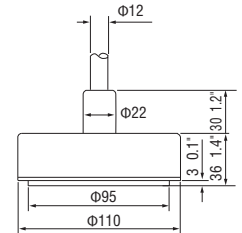

Transceiver Unit

FE-8020
10 kg 22.1 lb

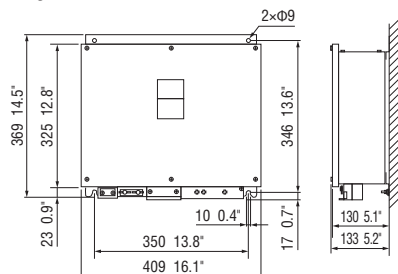

Transducer Tank

TTF-5600 (for 50B-6B)
Standard T=20: 18 kg 39.7 lb
Option T=12: 15 kg 33.1 lb
Option T=25: 20 kg 44.1 lb

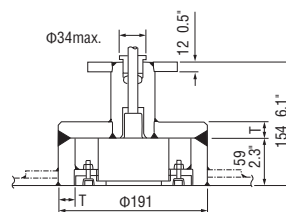

Transducer Tank

TTF-2000 (for 200B-8B)
Standard T=20: 20 kg 44.1 lb
Option T=12: 16 kg 35.3 lb
Option T=25: 22 kg 48.5 lb

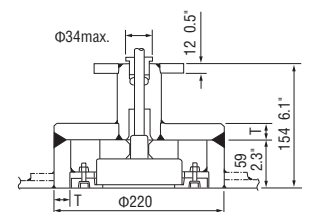

Relative Humidity	93% or less at 40°C	
Degree of protection	Display Unit	IP22
	Transceiver Unit	IP22 (wallmount) / IP20 (tabletop mount)
	Matching Box	IP45
Vibration	IEC 60945 Ed. 4	

EQUIPMENT LIST

Standard

1. Display Unit	FE-8010	1 unit	
2. Transceiver Unit	FE-8020	1 unit	
3. Transducer	50B-6B	1 unit	cable: 15/30/50 m
	200B-8B		cable: 15/30/50 m
4. Matching Box	MB-502	1 unit	for 50B-6B
	MB-504		for 200B-8B
5. Transducer Tank	TTF-5600	1 unit	for 50B-6B
	TTF-2000		for 200B-8B

Option

1. Transceiver Unit	FE-8020		
2. Transducer	50B-6B		cable: 15/30/50 m
	200B-8B		cable: 15/30/50 m
3. Matching Box	MB-502		for 50B-6B
	MB-504		for 200B-8B
4. Transducer Tank	TTF-5600		for 50B-6B
	TTF-5001		for 200B-8B
	TTF-2001		for 200B-8B
	TTF-5002		for 50B-6B (with flange)
5. Gate Valve	TTF-2002		for 200B-8B (with flange)
	GV-50B-6B		
	GV-200B-8B		
6. Printer	PP-900		
7. PC Software*	OP12-2		
8. LAN cable	DTI-C5e350		
9. Interface Unit	IF-2550		

* Runs under Windows 7 ® and Windows 8 ®

All brand and product names are registered trademarks, trademarks or service marks of their respective holders.
SPECIFICATIONS SUBJECT TO CHANGE WITHOUT NOTICE

FURUNO ELECTRIC CO., LTD.

www.furuno.com

Find your local contact point



C-2503LB
Catalogue No. CA000002631