

FURUNO

MODEL

FCV-600 / FCV-800

MODEL

TruEcho CHIRP™ Fish Finders



FCV-600
5.7" Display

FCV-800
8.4" Display



www.furuno.com

ACCU-FISH™, and Bottom Discrimination, in both shallow and deep water

COMBINE CW & TruEcho CHIRP™ FOR ADDED CAPABILITIES

By combining CHIRP and traditional CW transducers*, you'll see crisp CHIRP echoes on the screen while the ACCU-FISH™ and Bottom Discrimination functions from your CW transducer work in the background, overlaying important information on your CHIRP returns. You will be able to see fish targets, fish size assessment, fish depth, and bottom composition.** Up to three frequencies can be saved as preset selections.

*FCV-800 Single Frequency CHIRP only

**MF or HF CHIRP

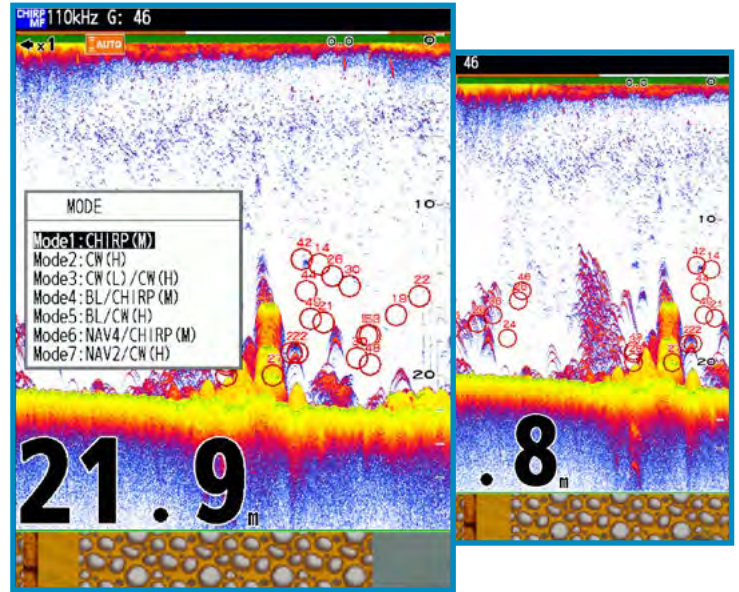

GLASS-COVERED, PIANO BLACK FRONT PANEL, EASY-TO-PRESS KEYS AND ROBUST RotoKey™:

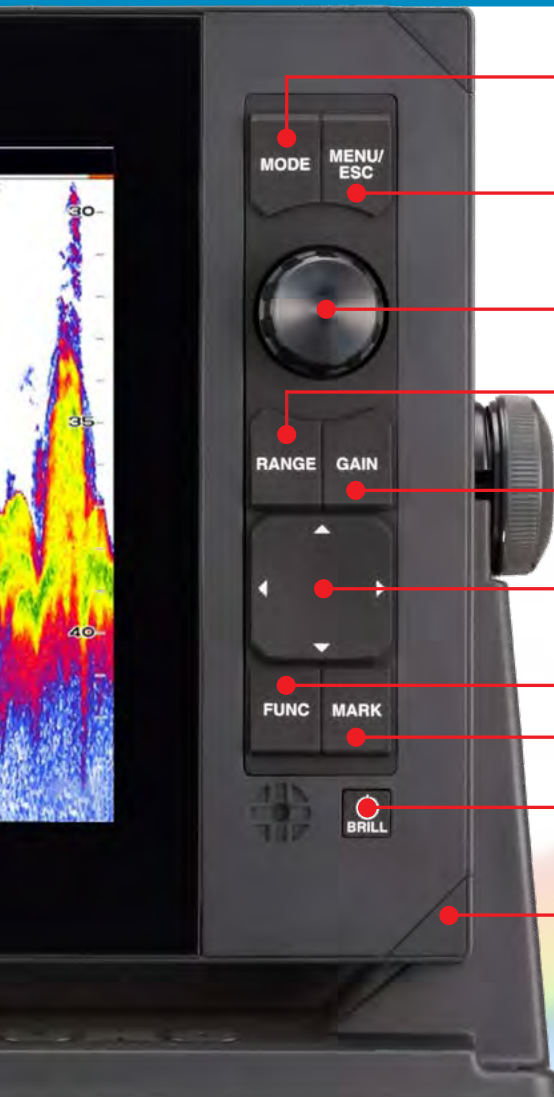

Mode Button

Menu Button

RotoKey™

Dedicated Range Key

Dedicated Gain Key

Cursor Pad

Function Key

Mark Key

Power/Brilliance

Easy access from front for flush mount (FCV-800 only)

FCV-600
5.7" Display



FCV-800
8.4" Display

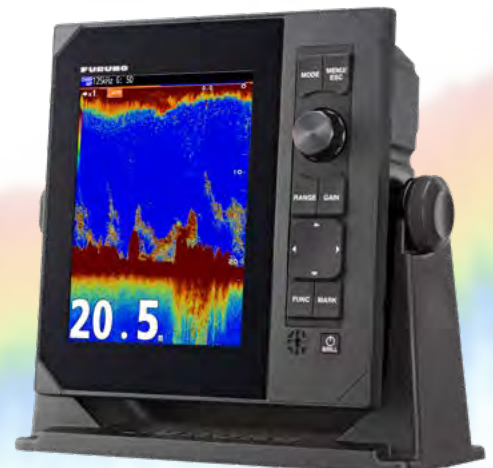

Boost your catch with TruEcho CHIRP™, combining multi-frequency features



FISH FINDER TECHNOLOGY JUST TOOK A BIG LEAP WITH TruEcho CHIRP™ AND COMBINED FREQUENCY FEATURES!

NEW ENHANCED FEATURES

- ▶ **TruEcho CHIRP™** - Operates across a wide range of frequencies using a broadband transducer for better signal clarity & target definition
- ▶ **NEW! Combine TruEcho CHIRP™ & CW Transducers** - to see CHIRP targets, ACCU-FISH™, and Bottom Discrimination functions (FCV-800 only)
- ▶ **RezBoost™ Signal Processing** - Improved clarity & resolution for conventional CW transducers
- ▶ **ACCU-FISH™** - A unique fish size and depth assessment function
- ▶ **Bottom Discrimination** - Provides recognition of bottom composition with 4 types of graphic displays (Rock/Sand/Gravel/Mud)
- ▶ **NEW! Bottom Hardness Output** - for external plotters such as TZ Professional and Olex
- ▶ **NEW! Color Expansion** - Expands echo colors to easily identify fish from seabed
- ▶ **White Line Feature** - Finds fish lying near the bottom by displaying the top edge of the bottom in white to clearly show bottom structure
- ▶ **Post Processing Gain** - Adjust gain setting to screen history
- ▶ **Configurable Alarm Function** - Depth, Fish echo, Speed, Arrival, etc.
- ▶ **TLL (Target Lat/Lon) Output** - Interface with your Furuno Chart Plotter to mark fishing ground with various information such as Depth, Water Temp, Fish Size, and Bottom Type (Requires a Chart Plotter)
- ▶ **Fast Transmission Rate** - 3,000 PRR (Pulse Repetition Rate) per minute
- ▶ **NEW! Colors** - Sunlight and Yellow color palettes
- ▶ **NEW! Wireless Connectivity** - Allows secondary display capability

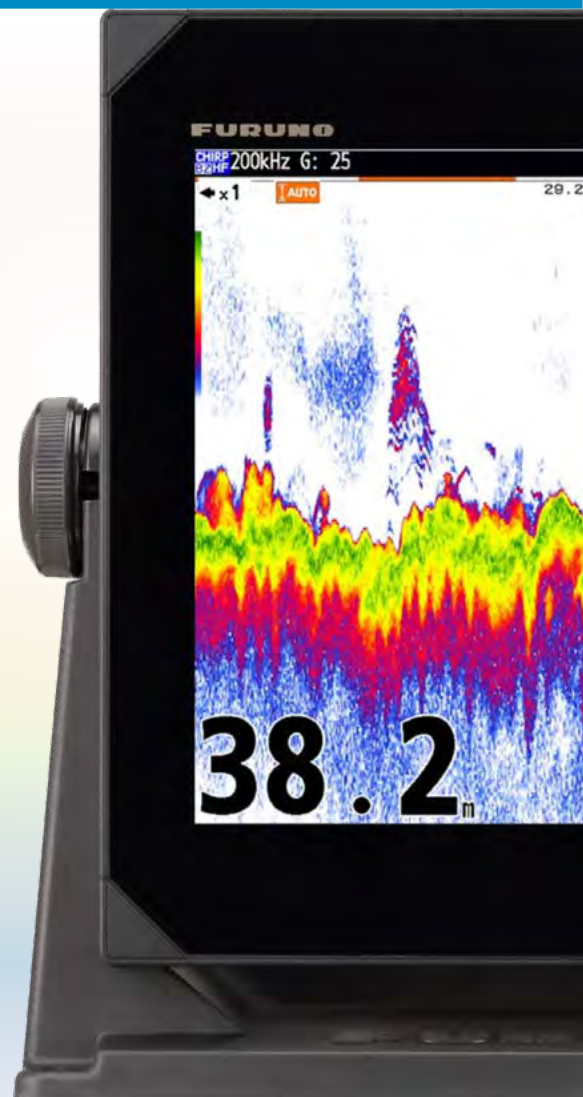

Furuno's revolutionary broadband, utilizing multiple transducers!

COLOR EXPANSION

Color Expand Off

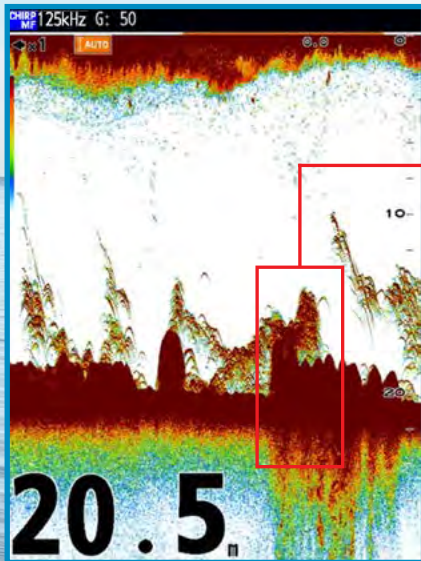

With the conventional color ranges, echoes from the seabed and a large fish are shown in a similar color, making it challenging to distinguish large fish from the bottom.

With Color Range Expansion, the range of identifiable echoes is expanded so you can intuitively identify bottom fish from the seabed. Reefs, structure, and fish near the seabed are shown in slightly separated colors, making it easy to tell structure from fish at a glance.

Color Expand On

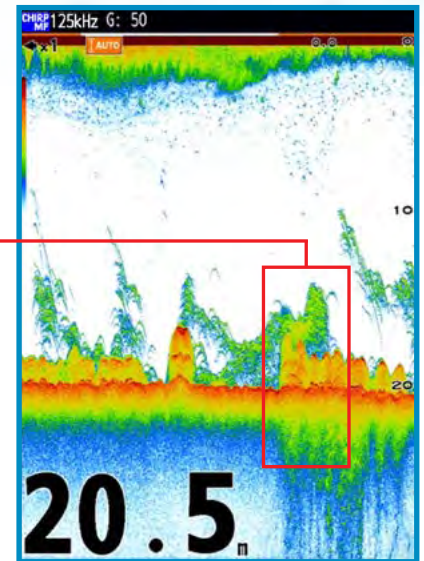

TruEcho CHIRP™

Traditional CW (Continuous Wave) Fish Finders transmit a signal composed of a single frequency, while CHIRP Fish Finders transmit a linear frequency-modulated signal - a wave with a frequency that increases over time. The FCV-600 and FCV-800 can utilize a broadband transducer to transmit across a spectrum of frequencies, resulting in better target resolution. With Furuno's TruEcho CHIRP™, you'll see greater detail and target separation for baitfish, game fish, and structure.



BOTTOM DISCRIMINATION

The Bottom Discrimination function enables the Fish Finder to indicate whether the bottom is composed mainly of rocks, gravel, sand, or mud, providing you with valuable information that helps locate rich fishing grounds and boost your catch of the day. The standard graphic display mode shows the most probable bottom composition by graphic or four colors, while the probability display mode shows the most probable bottom composition in graph form.

(Please read the operator's manual carefully before using this feature.)

Probability Mode:

- Rocks
- Sand
- Mud
- Gravel

Graphic Mode:

- Rocks
- Sand
- Mud
- Gravel



WIRELESS CONNECTIVITY

A second FCV-600/800 display or smart device with TZ iBoat app for iOS/iPadOS or NavNet Viewer for Android can be utilized to show the echoes and nav data from the FCV-600/800 via wireless network, so you can monitor the underwater situation from the stern or bow while fishing.



TZ iBoat app for iOS/iPadOS



NavNet Viewer app for Android



INTERCONNECTION DIAGRAM

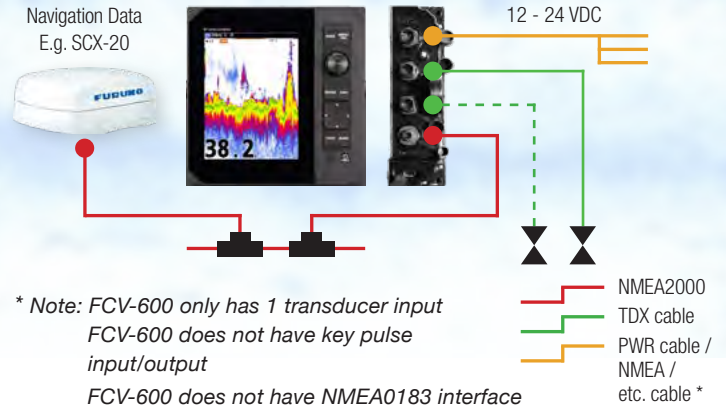

TRANSDUCERS

Specify when ordering - 1kW available only for FCV-800

CW Types

520-5PSD/MSD, 525-5PWD, 525STID-PWD, 525STID-MSD, 520-PLD, 525T-PWD, 525T-BSD, 525T-LTD/12, 525T-LTD/20, SS60-SLTD/12, SS60-SLTD/20, 200B-5S, 50B-6/6B, 50/200-IT, 526TID-HDD

CHIRP Types

B150M, TM150M, B75L, SS75L, B75M, P75M, P95M, SS75M, B785M, B75H, B75HW, SS75H, TM165HW, B175L, B175M, TM185M, B285M, B175H, B175HW, TM185HW, B285HW, B265LH, TM265LH, CM265LH, B265LM, TM265LM, CM-2265LM, B275LHW, B765LM, B765LH, TM275LHW, CM275LHW

ACCU-FISH™

ACCU-FISH™ size assessment function identifies individual fish instantaneously, a technology that is proprietary to Furuno. To assess individual fish size, echo returns are evaluated based on strength and turned into fish size display (10 to 199 cm, in depths of 2 to 100 m) on the screen.

(In some instances, fish size indicated may differ from actual size. Please read operator's manual carefully before using this feature.)

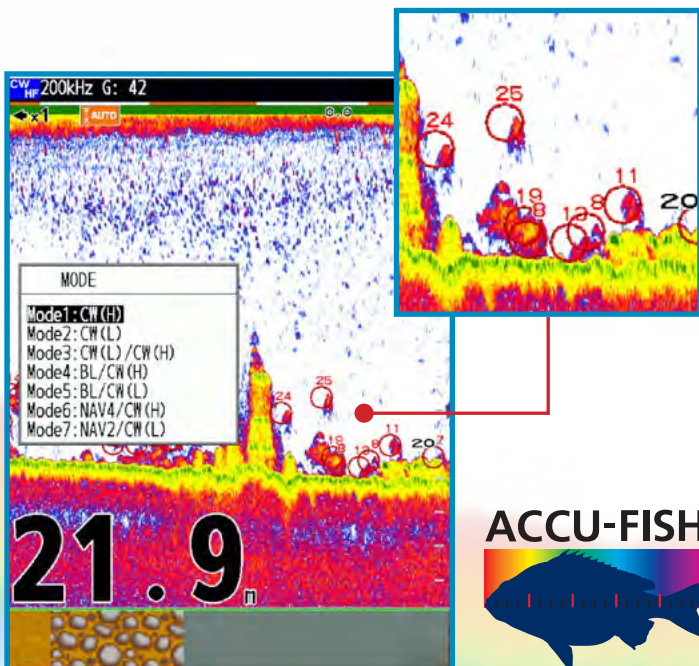

REZBOOST™

RezBoost™ is a revolutionary signal processing technology developed by Furuno that improves resolution and target separation using conventional CW narrowband transducers. Spot individual game fish surrounding bait balls and fish close to the seabed. With RezBoost™, you can expect higher resolution and crisper visuals and improvements in the ACCU-FISH™ function.

RezBoost™ can dramatically improve the capabilities of conventional narrowband transducers. Compared to conventional signal processing techniques (FDF), a RezBoost™ Fish Finder produces an image up to 8 times* clearer. What can be done with a conventional narrowband transducer, just like the one you might have installed on your vessel, is truly impressive.**



*RezBoost™ performance may vary depending on depth, range, and signal frequency used.

** The Enhanced mode of RezBoost™ capable thru-hull or transom mount transducer.

GENERAL

CW Frequency 50/200 kHz
 CHIRP Frequency 40 to 225 kHz

DISPLAY

FCV-600 5.7" (640x480 VGA - 1,000 cd/m²) – 600W Power Output
 FCV-800 8.4" (800x600 SVGA - 800 cd/m²) – 600W/1kW Power Output
 Display Single Frequency, Dual-Frequency, Zoom, Nav Data, A-Scope, Marker Zoom, Bottom-Lock, Bottom Discrimination, Color Expand, ACCU-FISH™, RezBoost™
 Language English, French, Spanish, German, Italian, Portuguese, Greek, Polish, Danish, Swedish, Norwegian, Finnish, Chinese, Japanese, Thai, Vietnamese, Indonesian, Myanmar (Burmese)
 Basic Range 2 - 1,200 m*
 *m, ft, fm, HR, pb can be selected in the menu
 Alarm Bottom, Fish (Normal), ACCU-FISH™, Fish (B/L), Bottom Discrimination, Fish Level, Temperature, Speed, Arrival, and Battery
 Range Phasing Up to 1,200 m
 Expansion Range Bottom-Lock Expansion; 2 - 10 m
 Sectional Expansion: 2 - 1,200 m
 Picture Advance 8 steps: stop, 1/16, 1/8, 1/4, 1/2, 1, 2, 4, 8
 Speed
 Pulse Length & PRR 0.04 to 3.0 ms, Max 3,000 pulse/min
 Interface (IEC61162-1, NMEA0183 Ver 1.0/2.0/3.0, NMEA2000)
 NMEA0183 Sentences (FCV-800 only)
 Input: BWC, GGA, GLL, GNS, HDG, HDT, MDA, MTW, MWV, RMA, RMB, RMC, THS, VHW, VTG, XTE, ZDA
 Output: DBS, DBT, DPT, MTW*, RMB*, VHW*, TLL* by key operation
 *External data required

NMEA2000 Sentences

Input: 059392, 059904, 060160, 060416, 060928, 061184, 065240, 065280, 126208, 126720, 126996, 127250, 127252, 127257, 128259, 129025, 129026, 129029, 129283, 129284, 130306, 130310, 130311, 130312, 130314, 130316, 130577, 130821
 Output: 059392, 059904, 060928, 061184, 126208, 126464, 126720, 126993, 126996, 126998, 128259, 128267, 130310, 130312, 130316, 130821, 130822, 130830, 130831, 130832

ENVIRONMENT

Temperature -15°C to +55°C
 Waterproofing IP56

POWER SUPPLY

FCV-600 12-24 VDC: 1.0 - 0.6 A
 FCV-800 12-24 VDC: 1.6 - 0.8 A

EQUIPMENT LIST

Standard

1. Display Unit With Bracket
2. Installation Materials and Standard Spare Parts

Option

1. Transducer: Specify When Ordering
2. Speed/Temperature Sensor: ST-02MSB, ST-02PSB, T-04MSB, T-04MTB
3. Connector Kit for Connection of Speed & Temperature Sensor or Temperature Sensor
4. NMEA + Power Cable
5. Flush Mount Kit: OP02-89 - FCV-600 / OP02-88 - FCV-800
6. Adapter Cable for FCV-800 - 1kW Dual-band CHIRP Transducer FRU-MJ10CCB12-300

DISPLAY UNIT

FCV-600

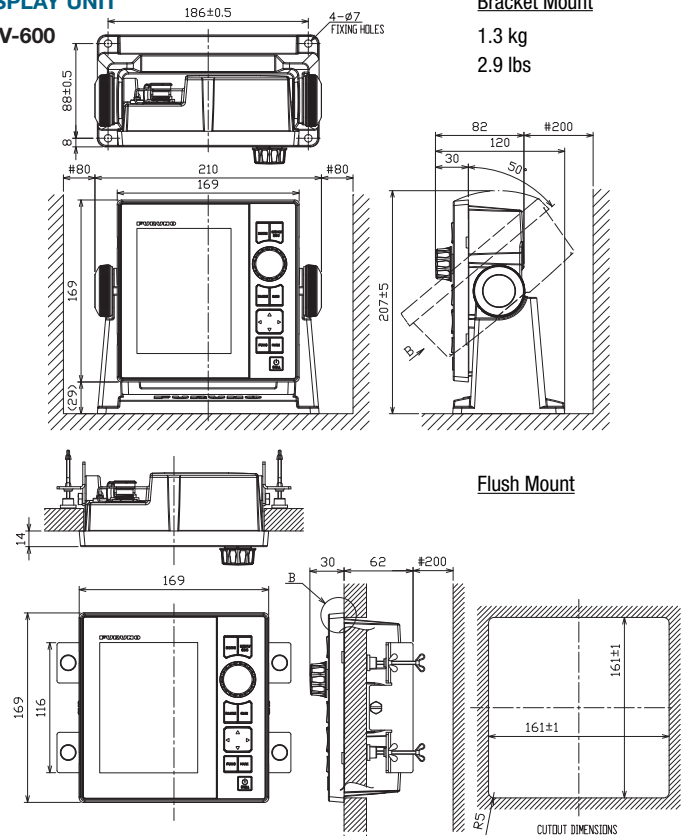

FCV-800

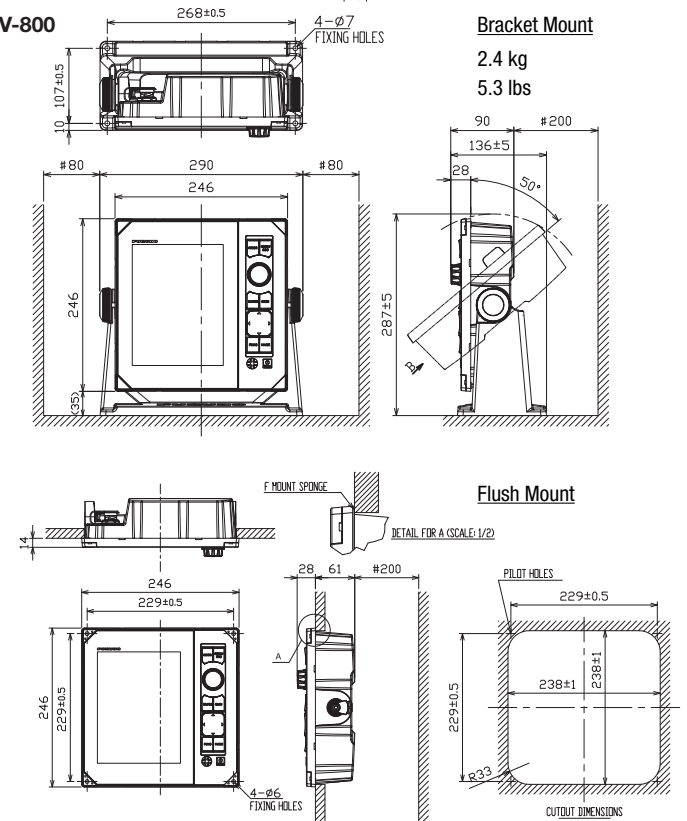

Catalog No. CA000002620

FURUNO ELECTRIC CO., LTD.
 www.furuno.com

Find your local contact point

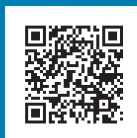

BEWARE OF SIMILAR PRODUCTS
 All brand and product names are trademarks, registered trademarks, or service marks for their respective holders.
SPECIFICATIONS SUBJECT TO CHANGE WITHOUT NOTICE