

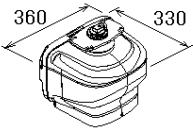

PACKING LIST

03IG-X-9852 -0 1/1

RSB-137-126-E

NAME	OUTLINE	DESCRIPTION/CODE No.	Q'TY
ユニット UNIT			
空中線本体部 ANTTENA UNIT		RSB-137-126 000-037-139-00	1
予備品 SPARE PARTS			
予備品 SPARE PARTS		SP03-19601 001-514-020-00	1
工事材料 INSTALLATION MATERIALS			
工事材料 INSTALLATION MATERIALS		CP03-37101 001-426-290-00	1
図書 DOCUMENT			
型紙 TEMPLATE		C32-00703-* 7/11 000-167-459-1*	1
装備要領書(英) INSTALLATION MANUAL (EN)		IME-36680-* 000-193-441-1*	1

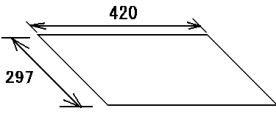
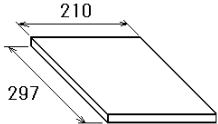
(略図の寸法は、参考値です。 DIMENSIONS IN DRAWING FOR REFERENCE ONLY.)

C3676-Z01-A