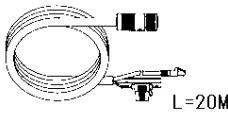
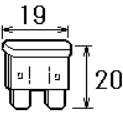
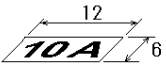
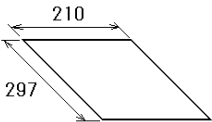

PACKING LIST

03HW-X-9856 -0 1/1

CP03-37420 *20M*

NAME	OUTLINE	DESCRIPTION/CODE No.	Q'TY
工事材料 INSTALLATION MATERIALS			
ケーブル(クミヒン) CABLE ASSEMBLY		FRU-2P5S-FF-20M 000-168-867-10	1
ヒューズ BLADE FUSE		ATV10A60V 000-192-660-10	1
ヒューズ ハリマーク FUSE LABEL		03-189-3915-0 100-412-050-10	1
ヒューズ 交換要領 HOW TO REPLACE THE FUSE		C32-01604-* 000-192-665-1*	1

(略図の寸法は、参考値です。 DIMENSIONS IN DRAWING FOR REFERENCE ONLY.)

C3647-Z06-A