

# **FURUNO**

## **OPERATOR'S MANUAL**

*NETWORK FISH FINDER*

Model **DFF1-UHD**

---



# IMPORTANT NOTICES

---

## General

- This manual has been authored with simplified grammar, to meet the needs of international users.
- The operator of this equipment must read and follow the instructions in this manual. Wrong operation or maintenance can void the warranty or cause injury.
- Do not copy any part of this manual without written permission from FURUNO.
- If this manual is lost or worn, contact your dealer about replacement.
- The contents of this manual and the equipment specifications can change without notice.
- The example screens (or illustrations) shown in this manual can be different from the screens you see on your display. The screens you see depend on your system configuration and equipment settings.
- Save this manual for future reference.
- Any modification of the equipment (including software) by persons not authorized by FURUNO will void the warranty.
- The following concern acts as our importer in Europe, as defined in DECISION No 768/2008/EC.
  - Name: FURUNO EUROPE B.V.
  - Address: Siriusstraat 86, 5015 BT, Tilburg, The Netherlands
- The following concern acts as our importer in UK, as defined in SI 2016/1025 as amended SI 2019/470.
  - Name: FURUNO (UK) LTD.
  - Address: West Building Penner Road Havant Hampshire PO9 1QY, U.K.
- All brand, product names, trademarks, registered trademarks, and service marks belong to their respective holders.

## How to discard this product

Discard this product according to local regulations for the disposal of industrial waste. For disposal in the USA, see the homepage of the Electronics Industries Alliance (<http://www.eiae.org/>) for the correct method of disposal.

## How to discard a used battery

Some FURUNO products have a battery(ies). To see if your product has a battery, see the chapter on Maintenance. If a battery is used, tape the + and - terminals of the battery before disposal to prevent fire, heat generation caused by short circuit.

### In the European Union

The crossed-out trash can symbol indicates that all types of batteries must not be discarded in standard trash, or at a trash site. Take the used batteries to a battery collection site according to your national legislation and the Batteries Directive 2006/66/EU.

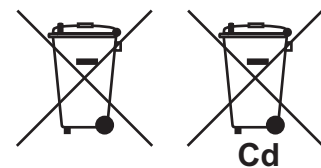

### In the USA

The Mobius loop symbol (three chasing arrows) indicates that Ni-Cd and lead-acid rechargeable batteries must be recycled. Take the used batteries to a battery collection site according to local laws.

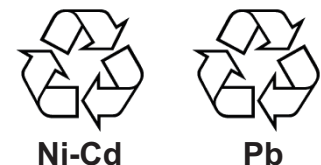



### In the other countries

There are no international standards for the battery recycle symbol. The number of symbols can increase when the other countries make their own recycle symbols in the future.









# SAFETY INSTRUCTIONS





The user and installer must read the appropriate safety instructions before attempting to install or operate the equipment.

 <b>WARNING</b>	Indicates a potentially hazardous situation which, if not avoided, could result in death or serious injury.
 <b>CAUTION</b>	Indicates a potentially hazardous situation which, if not avoided, may result in minor or moderate injury.

 Warning, Caution	 Prohibitive Action	 Mandatory Action
--	--	--

## Safety instructions for the operator

 <b>WARNING</b>	
	<b>Do not open the equipment.</b> Only qualified personnel can work inside the equipment.
	<b>Do not disassemble or modify the equipment.</b> Fire, electrical shock or serious injury can result.
	<b>Turn off the power immediately if the equipment is emitting smoke or fire.</b> Fire or electrical shock can result if the power is left on.
	<b>Turn off the power immediately if water leaks into the equipment or an object is dropped inside the equipment.</b> Continued use can cause fire or electrical shock.
	<b>Turn off the power immediately if you feel the equipment is acting abnormally.</b> If the equipment is hot to the touch or is emitting strange noises, turn off the power immediately and contact your dealer for advice.







 <b>WARNING</b>	
	<b>Do not operate the equipment with wet hands.</b> Electrical shock can result.
	<b>Do not place liquid-filled containers on the top of the equipment.</b> Electrical shock can result.
	<b>Use the proper fuse.</b> Use of a wrong fuse can damage the equipment and may cause fire.





**A warning label is attached to the equipment. Do not remove the label. If the label is missing or illegible, contact a FURUNO agent or dealer about replacement.**

 <b>WARNING</b> 
To avoid electrical shock, do not remove cover. No user-serviceable parts inside.
 <b>警告</b> 
感電の恐れあり。 サービスマン以外の方はカバーを開けないで下さい。内部には高電圧部分が数多くあり、万一さわると危険です。

Name: Warning Label (1)  
Type: 86-003-1011-3  
Code No.: 100-236-233-10

**Safety instructions for the installer**

 <b>WARNING</b>	
	<p><b>Do not work inside the equipment unless qualified to do so.</b></p> <p>Electrical shock can occur.</p>
	<p><b>Turn off the power before beginning the installation.</b></p> <p>Fire or electrical shock can result if the power is left on.</p>
	<p><b>Be sure no water leaks at the mounting location for the transducer and temperature sensor.</b></p> <p>Water leakage can sink the vessel. Also, confirm that neither the transducer nor the sensor will loosen by vibration. The installer is solely responsible for the installation.</p>
	<p><b>Confirm that the power supply voltage is within the rating of this equipment.</b></p> <p>Incorrect voltage will damage the equipment and may cause fire.</p>
	<p><b>The network sounder meets waterproofing standard IP55. However, do not install the sounder outdoors.</b></p> <p>Fire or electrical shock can result if water gets inside the equipment.</p>

 <b>CAUTION</b>					
	<p><b>The transducer cable must be handled carefully, following the guidelines below.</b></p> <ul style="list-style-type: none"> <li>• Keep fuels and oils away from the cable.</li> <li>• Locate the cable away from chemicals.</li> <li>• Locate the cable away from locations where it might be damaged.</li> </ul>				
	<p><b>Do not apply the power with the transducer exposed to air.</b></p> <p>The transducer may be damaged.</p>				
	<p><b>A magnetic compass may receive interference if it is placed too close to the network fish finder. Observe the compass safe distances shown below to prevent interference to a magnetic compass.</b></p> <table border="1" style="margin-left: auto; margin-right: auto;"> <tbody> <tr> <td style="text-align: center;">Standard compass</td> <td style="text-align: center;">Steering compass</td> </tr> <tr> <td style="text-align: center;">0.70 m</td> <td style="text-align: center;">0.40 m</td> </tr> </tbody> </table>	Standard compass	Steering compass	0.70 m	0.40 m
Standard compass	Steering compass				
0.70 m	0.40 m				

# TABLE OF CONTENTS

---

<b>FOREWORD</b> .....	<b>v</b>
<b>SYSTEM CONFIGURATION</b> .....	<b>vi</b>
<b>1. INSTALLATION</b> .....	<b>1</b>
1.1 Equipment Lists.....	1
1.2 Network Fish Finder .....	2
1.3 Transducer .....	3
1.4 Optional Speed/Temperature Sensors ST950-FJ46-1, ST950-FJ46-2.....	3
1.4.1 Mounting considerations.....	3
1.4.2 Mounting procedure.....	3
<b>2. WIRING</b> .....	<b>4</b>
2.1 Wiring Outline.....	4
2.2 Transducer Cable, Cable for External KP (option).....	5
2.2.1 How to prepare the cables.....	5
2.2.2 How to connect the transducer cable .....	7
2.2.3 How to connect the cable for the external KP.....	9
2.3 LAN Cable.....	11
<b>3. INITIAL SETTINGS</b> .....	<b>13</b>
3.1 DIP Switch Setting .....	13
3.2 Operation Check .....	14
<b>4. MAINTENANCE</b> .....	<b>15</b>
4.1 Maintenance.....	15
4.2 How to Replace the Fuse.....	16
4.3 How to Restore Default Settings.....	16
<b>APPX. 1 JIS CABLE GUIDE</b> .....	<b>AP-1</b>
<b>APPX. 2 INSTALLATION OF TRANSDUCERS</b> .....	<b>AP-2</b>
<b>APPX. 3 INSTALLATION OF TEMPERATURE SENSORS</b> .....	<b>AP-7</b>
<b>SPECIFICATIONS</b> .....	<b>SP-1</b>
<b>PACKING LIST</b> .....	<b>A-1</b>
<b>OUTLINE DRAWING</b> .....	<b>D-1</b>
<b>INTERCONNECTION DIAGRAM</b> .....	<b>S-1</b>

# FOREWORD

---

## A Word to the Owner of the DFF1-UHD

Congratulations on your choice of the FURUNO DFF1-UHD Network Fish Finder. We are confident you will see why the FURUNO name has become synonymous with quality and reliability. Since 1948, FURUNO Electric Company has enjoyed an enviable reputation for quality marine electronics equipment. This dedication to excellence is furthered by our extensive global network of agents and dealers. This equipment is designed and constructed to meet the rigorous demands of the marine environment. However, no machine can perform its intended function unless operated and maintained properly. Please carefully read and follow the recommended procedures for operation and maintenance.

Thank you for considering and purchasing FURUNO.

## Features

The DFF1-UHD is a dual frequency echo sounder designed for use with the NavNet 3D (MFD8/12/BB), NavNet TZtouch (TZT9/14/BB) and NavNet TZtouch2 (TZTL12F/15F, TZT2BB). The DFF1-UHD feeds data about underwater conditions via a LAN connection.

- FURUNO TruEcho CHIRP™ fish finders provide very high definition images.
- High resolution display greatly reduces the possibility of missing a target.
- Noise-suppressing display for enhanced detection performance.
- Fish size shown for depths up to 200 m and bottom discrimination.

## Operational cautions

- Echoes are shown in high ultra definition, thus echoes are displayed differently from those presented on the conventional fish finder.
- The interference rejector operates differently from the interference rejector on the conventional fish finder, thus its effect on echoes is different.
- The transducer cannot be installed inside the vessel.
- Observe the following when using the ACCU-FISH™ feature:
  - Use the feature where the depth is 2 - 200 m.
  - The length of the TX pulse changes according to whether the feature is on or off. The appearance of the display changes with the sensitivity.
- Observe the following when using the bottom discrimination display (hereafter referred to as BDD):
  - Use the BDD under the following conditions:
    - Depth: 5-200 m (16.4-656.2 ft)
    - Speed: 10 knots or less"
  - The BDD uses depth measured from the vessel's draft in its analysis of bottom composition. Be sure to set the draft at the NavNet 3D/TZtouch/TZtouch2.
  - The TX interval slows when the BDD is active.
  - The BDD is inoperative if the transducer selection setting at the NavNet 3D/TZtouch/TZtouch2 is "Manual".
  - The BDD provides an estimate of bottom composition. Actual composition may be different.

### Measure for reduction of interference

If you receive interference from the fish finder/echo sounder of another vessel, switch to single frequency operation and change the frequency and/or reduce the transmitting sound pressure level to remove the interference.

### CE/UKCA declaration

With regards to CE/UKCA declarations, please refer to our website ([www.furuno.com](http://www.furuno.com)) for further information about RoHS conformity declarations.

### Disclosure of Information about China RoHS

With regards to China RoHS information for our products, please refer to our website ([www.furuno.com](http://www.furuno.com)).

# SYSTEM CONFIGURATION

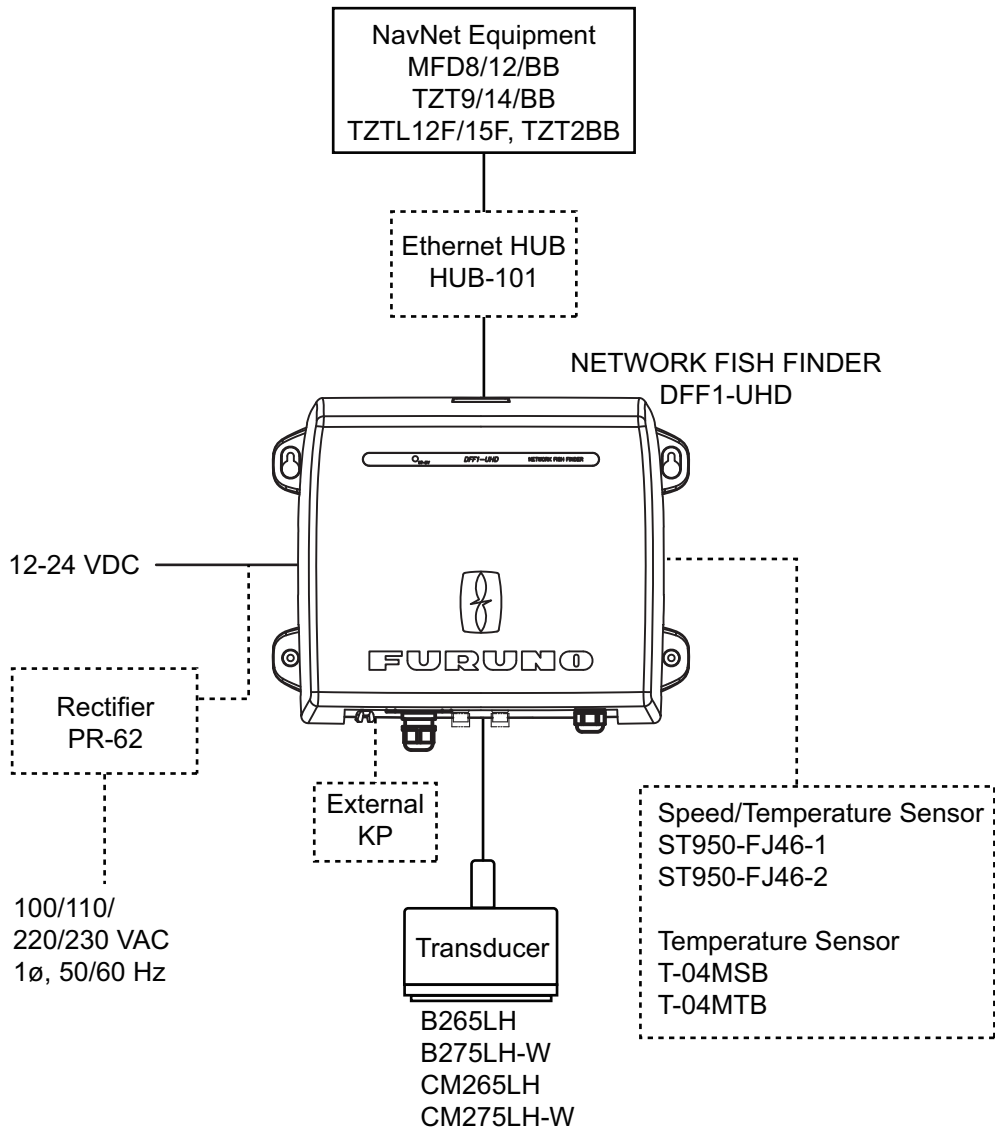

# 1. INSTALLATION

## 1.1 Equipment Lists

### Standard supply

Name	Type	Code No.	Qty	Remarks
Network Fish Finder	DFF1-UHD	-	1	
Spare Parts	SP02-05601	001-033-740	1 set	Fuse (2 pcs.)
Installation Materials	CP02-08500	000-011-917	1 set	- Power cable assy. (3.5 m) - LAN cable assy. (5 m) - Self-tapping screws

### Optional supply

Name	Type	Code No.	Remarks
Transducer	B265LH	000-022-521	1 kW, bronze housing, thru hull
	B275LH-W*	000-027-419	1 kW, bronze housing, thru hull, wide beam
	CM265LH	000-022-531	1 kW, plastic housing, tank mount
	CM275LH-W*	000-027-408	1 kW, plastic housing, tank mount, wide beam
Thru-hull pipe	TFB-7000	000-022-532	
Tank	T-711	000-022-539	
Cable Assembly	MOD-Z072-020+	001-167-880-10	2 m, for HUB-101
Cable Assembly	MOD-Z072-100+	001-167-900-10	10 m, for HUB-101
Speed/Temperature Sensor	ST950-FJ46-1	000-200-363-10	Thru-hull mount, plastic
	ST950-FJ46-2	000-200-364-10	Thru-hull mount, stainless steel
Temperature Sensor	T-04MSB	000-026-893	Thru-hull mount
	T-04MTB	000-026-894	Transom mount
Rectifier	PR-62	000-013-484	100 VAC
		000-013-485	110 VAC
		000-013-486	220 VAC
		000-013-487	230 VAC
Connector Kit for TX Sync	OP02-86	001-205-780	

\*: Not compatible with Bottom Discrimination Display and ACCU-FISH™ features.

## 1.2 Network Fish Finder

The network fish finder can be installed on a desktop, deck or on a bulkhead. When selecting a mounting location, keep the following points in mind:

- This unit meets the waterproofing standard IP55. However, do not install the unit outdoors.
- The operating temperature range of this unit is -15 to 55°C (5°F to 131°F). Be sure the mounting location satisfies this requirement.
- Locate the unit away from exhaust pipes and vents.
- The mounting location should be well ventilated.
- Mount the unit where shock and vibration are minimal.
- Keep the unit away from electromagnetic field-generating equipment such as motors and generators.
- Leave slack in cables for maintenance and servicing ease.
- A magnetic compass may receive interference from the network fish finder if it is placed too close to the network fish finder. Observe the compass safe distances noted in the safety instructions to prevent interference to the magnetic compass.
- For mounting on a bulkhead, the connectors must face downward.



Fasten the network fish finder to the mounting location with four self-tapping screws (5×20), referring to the outline drawing at the back of this manual for mounting dimensions.

## 1.3 Transducer

The performance of the fish finder largely depends upon the transducer position. Select a place least affected by air bubbles since turbulence blocks the sounding path. The face of the transducer must be facing the sea bottom in normal cruising trim of the boat. Further, select a place least influenced by engine noise. It is known that air bubbles are fewest at the place where the bow first falls and the next wave rises, at usual cruising speed.

Do not install the transducer inside the hull. Performance cannot be guaranteed.

## 1.4 Optional Speed/Temperature Sensors ST950-FJ46-1, ST950-FJ46-2

### 1.4.1 Mounting considerations

- Select a mid-boat flat position. The sensor does not have to be installed perfectly perpendicular. However, the sensor must not be located where it may be damaged in dry-docking operations.
- Select a place apart from equipment generating heat.
- Select a place in the forward direction viewing from the drain hole, to allow for circulation of cooling water.
- Select a place free from vibration.
- Do not install near the transducer of an echo sounder, to prevent interference to the echo sounder.

### 1.4.2 Mounting procedure

1. Dry dock the boat.
2. Make a hole of approx. 51 mm in diameter in the mounting location.
3. Unfasten the locknut and remove the sensor section.
4. Apply high-grade sealant to the flange of the sensor.
5. Pass the sensor casing through the hole.
6. Face the notch on the sensor toward boat's bow and tighten the flange.
7. Set the sensor section to the sensor casing and tighten the locknut.
8. Launch the boat and check for water leakage around the sensor.

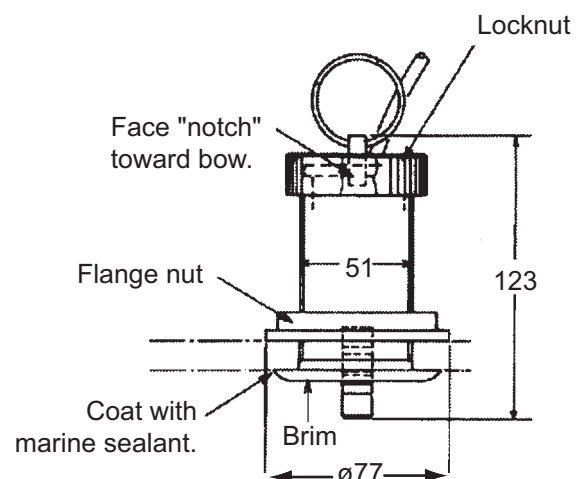

# 2. WIRING

## 2.1 Wiring Outline

Connect the power cable, transducer cables, sensor cable, network cable and ground wire to their respective locations on the network fish finder. See the next page for how to connect the transducer cable.

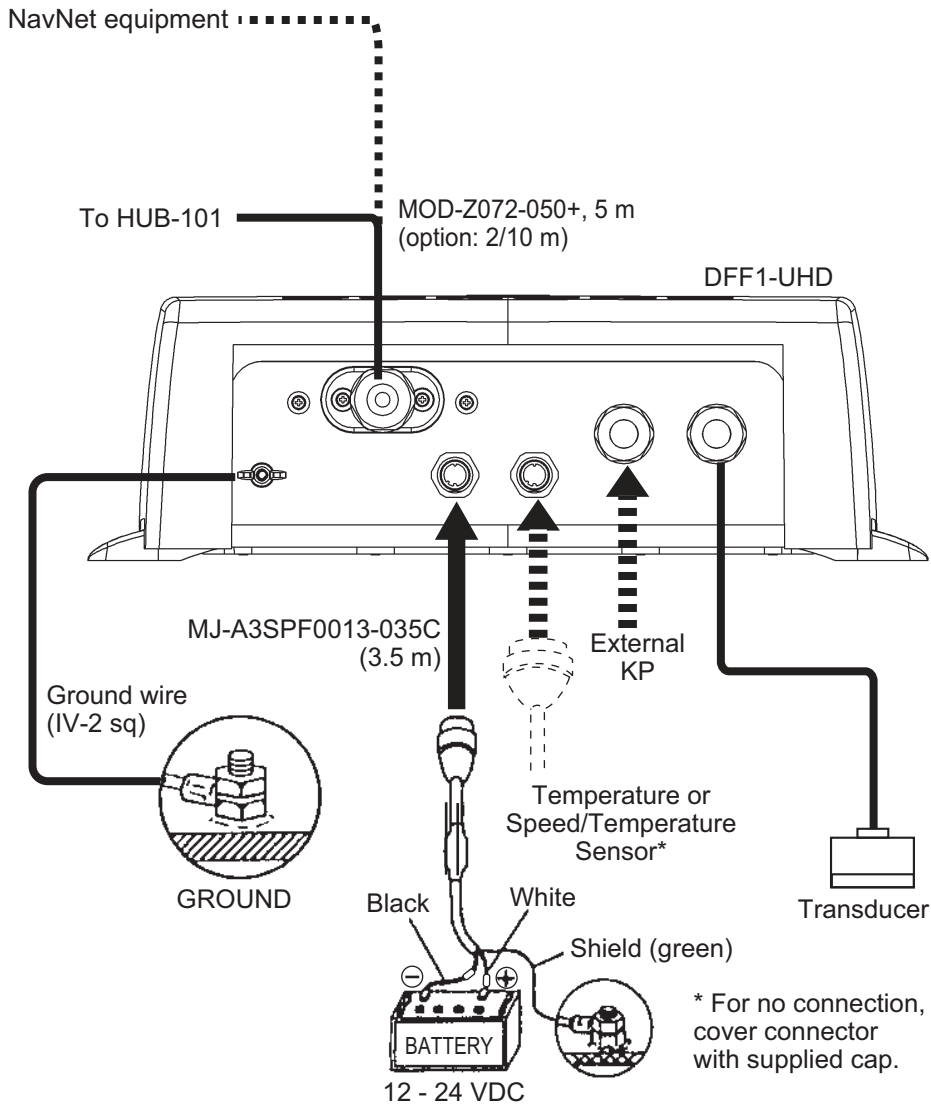

### Ground

Connect a ground wire (1V-2 sq, local supply) between the ground terminal and ship's ground to prevent interference to the sounder picture. Make the length of the wire as short as possible. For FRP vessels, install a ground plate that measures approx. 20 cm by 30 cm on the outside of the hull bottom and connect the ground wire there.

	<b>CAUTION</b>
	<b>Ground the equipment to prevent mutual interference.</b>

## 2.2 Transducer Cable, Cable for External KP (option)

If the external KP is not to be connected, do only the applicable procedures in section 2.2.1 and 2.2.2.

The KP from an echo sounder or sonar can be connected to this network fish finder to synchronize transmission between the sounder and this network fish finder. Use the optional Connector Kit for TX Sync (Type, OP02-86, Code No. 001-205-780) and cable MPYC-4 (or MPYC-2) for the connection. (The MPYC-4 is a Japan Industrial Standard (JIS) cable. If not available locally, see the Appendix 1 for how to select the equivalent cable.)

### Connector kit for TX sync

Name	Type	Code No.	Qty	Remarks
Upset UI Screw-B	M4×20	000-163-756-10	2	
Super Gland	MGB20M-12B	000-177-248-10	1	
PH Connector Assembly	02-1097 (4P)	001-206-000	1	
Cable Clamping Plate	02-167-1528	100-379-090-10	1	
Rainproof Panel	02-167-1529	100-379-100	1	No use. May be discarded.
EMI Core	GRFC-10	000-177-010-10	1	
Crimp-on Lug	NCW-1.25	000-157-213-10	4	

### 2.2.1 How to prepare the cables

**Note:** The label on the transducer cable can be removed if it interferes with treatment of the cable.

#### How to prepare the transducer cable

1. Fabricate the transducer cable(s) as shown below.

Fabricate the cables for both the high and low frequencies. For a CHIRP transducer, fabricate the ID signal and both the high and low frequencies cores. Refer to the interconnection diagram.

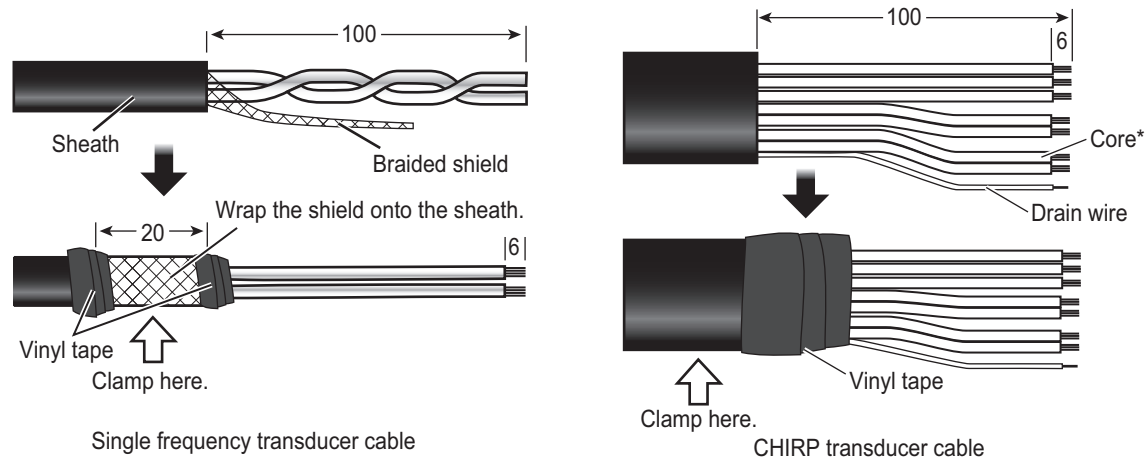

\* : Cut the purple signal core.

**Note:** When the previous CHIRP transducer cable (with 4 drain wires and braided shield) is used, turn back the shield onto the sheath and fix with vinyl tape.

## 2. WIRING

### How to prepare the cable for the external KP

1. Prepare the PH connector (02-1097, optional supply) as shown below.
  - a) Make the length of the wires of the PH connector 100 mm.
  - b) Remove the sheath from the cores 10 mm.
  - c) Fold back the cores in half.
  - d) Attach crimp-on lug NCW-1.25 to each core.

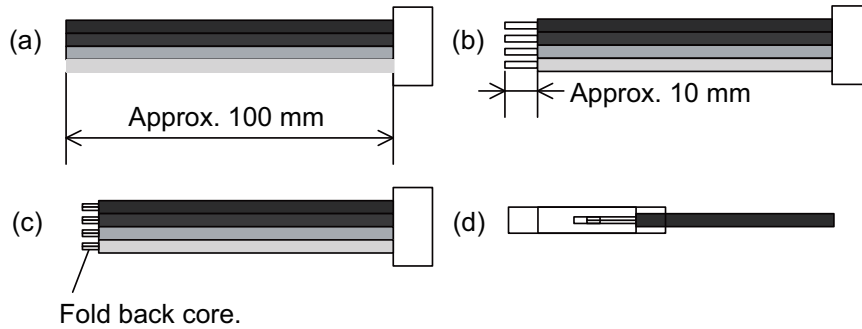

2. Remove the armor 210 mm and cut off the vinyl sheath 90 mm.

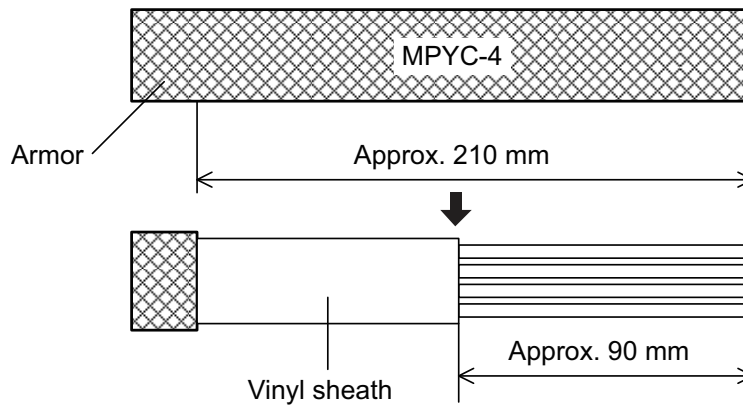

3. Remove 5 mm of the vinyl sheath from the cores then connect each crimp-on lug (attached at step 2) as shown below.

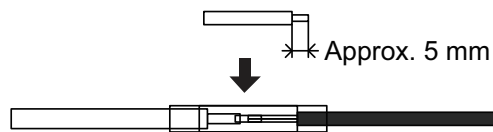

4. Wrap the armor with vinyl tape.

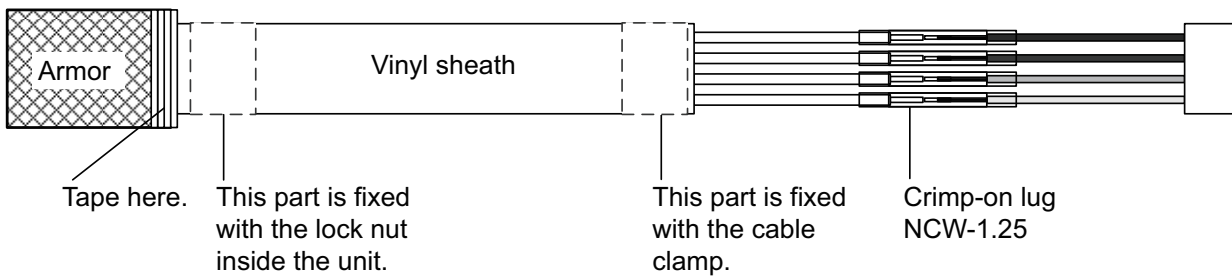

### 2.2.2 How to connect the transducer cable

This procedure shows you how to connect the transducer cable.

1. Open the cover - grasp the cover at two sides, spread the cover slightly and lift.
2. Loosen four screws to remove the shield cover.
3. Detach the two WAGO connectors (TB3, TB4) inside the equipment.

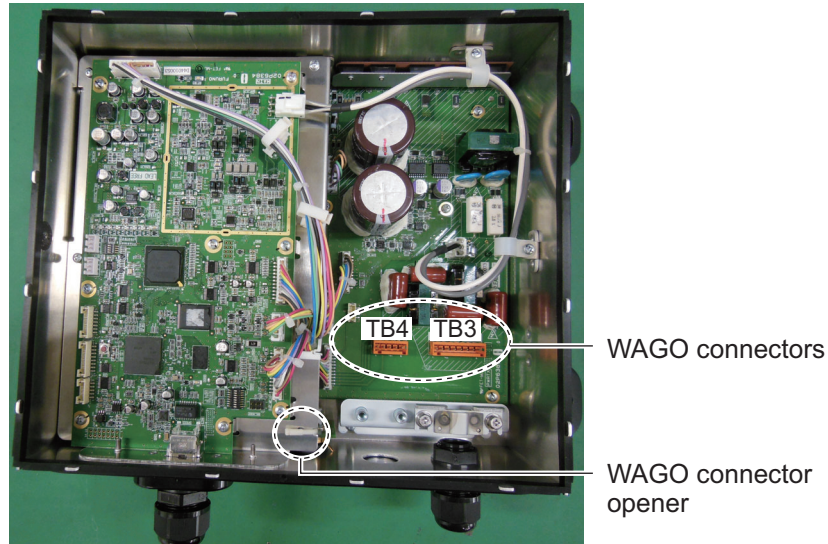

4. Unfasten the sealing nut from the super gland for the transducer cable.

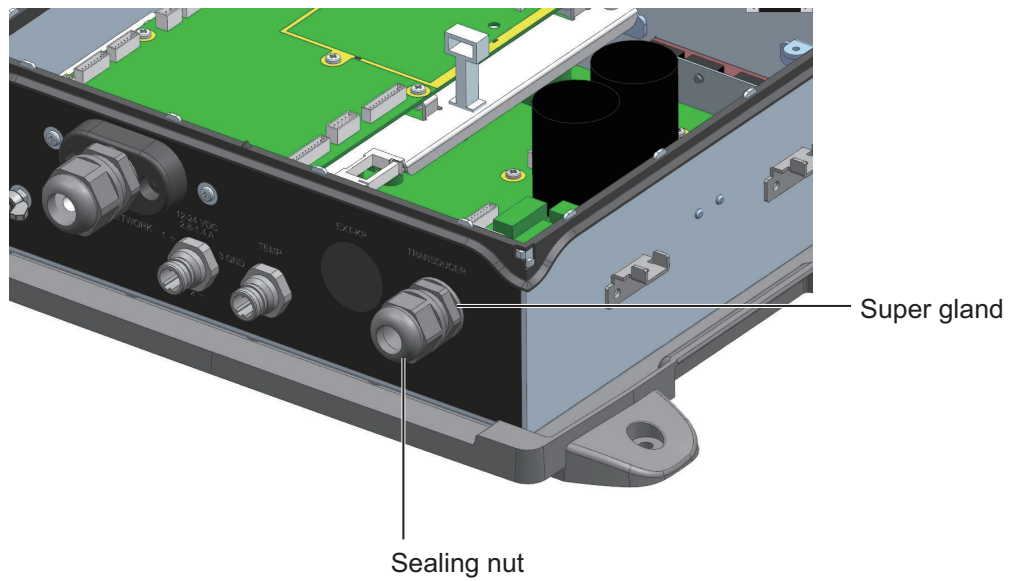

2. WIRING

5. Loosen two screws to unfasten the clamp fixing plate for the transducer cable.

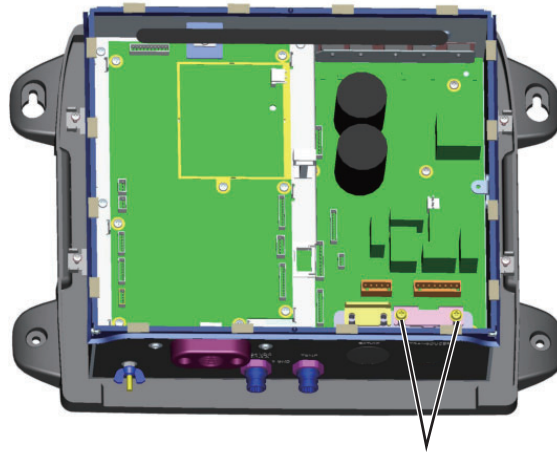

Loosen two screws to unfasten cable clamping plate for transducer cable.

6. Pass the transducer cable through the sealing nut and super gland and into the unit.  
 7. Use the WAGO connector opener, attached inside the equipment (see the figure on page 7 for the location), to connect the transducer cable to the WAGO connectors, following the instructions in the figure below and the interconnection diagram.

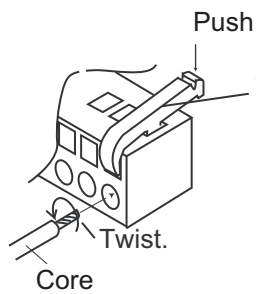

1. Twist conductors.
2. Insert opener as directed and press it down.
3. Insert conductor to hole.
4. Release opener.
5. Pull the core to make sure it is correctly inserted.

8. Reattach the WAGO connectors to the circuit board.  
 9. Fasten the cables with the clamp fixing plate.  
 For a single frequency transducer, clamp the braided shield. For a CHIRP transducer, clamp the vinyl sheath.

**Note:** For previous CHIRP transducer cable, connect the drain wires to the connector and clamp the shield.

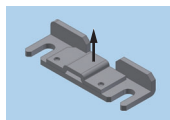
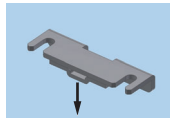
Transducer model	Clamp fixing plate orientation	
CM265LH/ CM275LH-W	Projection on plate upward	
B265LH/ B275LH-W	Projection on plate downward	

10. Tighten the sealing nut according to the information in the table below.

Transducer	Clearance between super gland and sealing nut		Torque
CM265LH/ CM275LH-W	4 mm		1.8 - 2.0 Nm
B265LH/ B275LH-W	2 mm		

11. Reattach the shield cover and close the outer cover.

### 2.2.3 How to connect the cable for the external KP

1. Remove the cover, shield cover. (See step 1 in section 2.2.2 for how to open the cover.)
2. Detach the protective sheet from the location for the external KP.

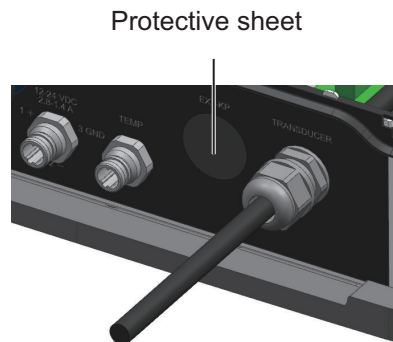

3. Do the following:

- 1) Unfasten the sealing nut and lock nut from the supplied super gland. As shown below, pass the cable through the sealing nut, super gland, hole in the network fish finder and the lock nut.
- 2) Prepare the cable end, referring to "How to prepare the cable for the external KP" on page 6.

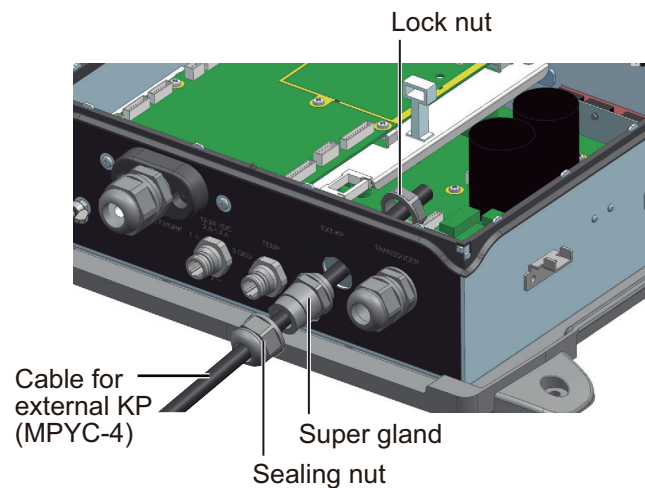

## 2. WIRING

4. Tighten the lock nut.
5. Tighten the sealing nut until the clearance between the nut and super gland is 4 mm. The torque for the sealing nut is 1.8 - 2.0 Nm.
6. Position the cable so the vinyl sheath lies in the cable clamp then use the supplied clamp fixing plate and two upset screws to secure the cable.

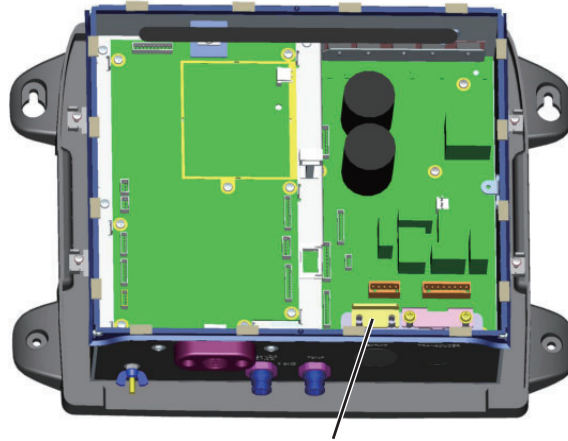
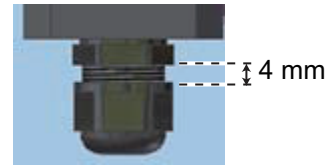

Clamp fixing plate  
for external KP

7. Pass the cable through the edge saddle shown below then connect the cable to J12 on the PWRTX board. Be sure the cable does not contact TB4.

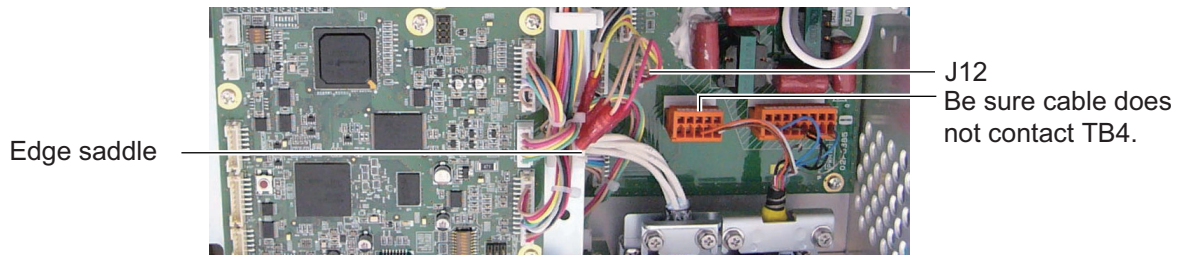

**Note:** For cable MPYC-2, tape the vinyl sheath of the cable (approx. 6 to 7 turns) where it lies in the cable clamp and fasten the cable clamp. The PH connector has two unused harnesses. Cut them at their base or wrap them with vinyl tape.

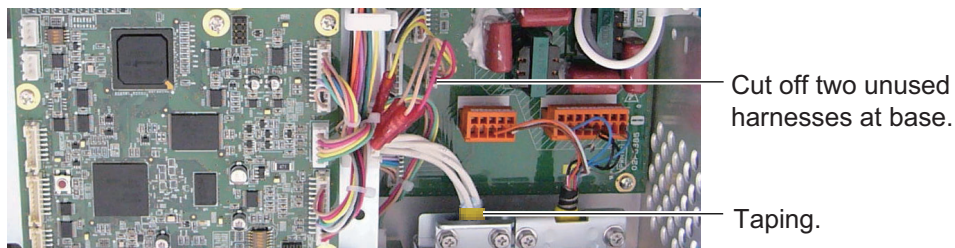

- Attach the supplied EMI core (GRFC-10) to the cable for the external KP, approx. 10 mm from the super gland.

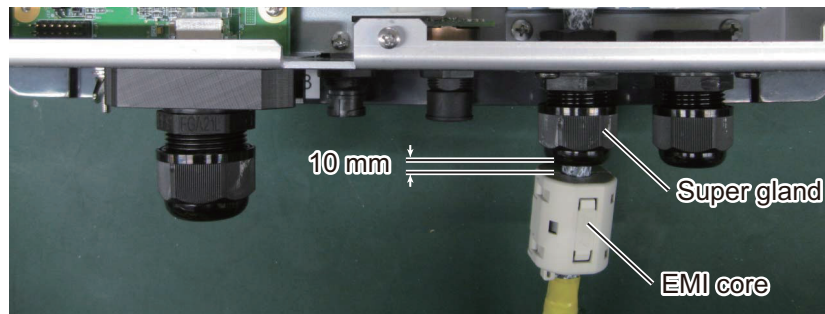

- Attach the shield cover and close the cover.

## 2.3 LAN Cable

Do as follows to connect the supplied LAN cable (MOD-Z072-050+) or the optional LAN cable (MOD-Z072-020+, MOD-Z072-100+).

- Unfasten the sealing nut from the LAN connector then remove the sealing insert and clamping claw.
- Detach the sealing insert from the clamping claw as shown below.

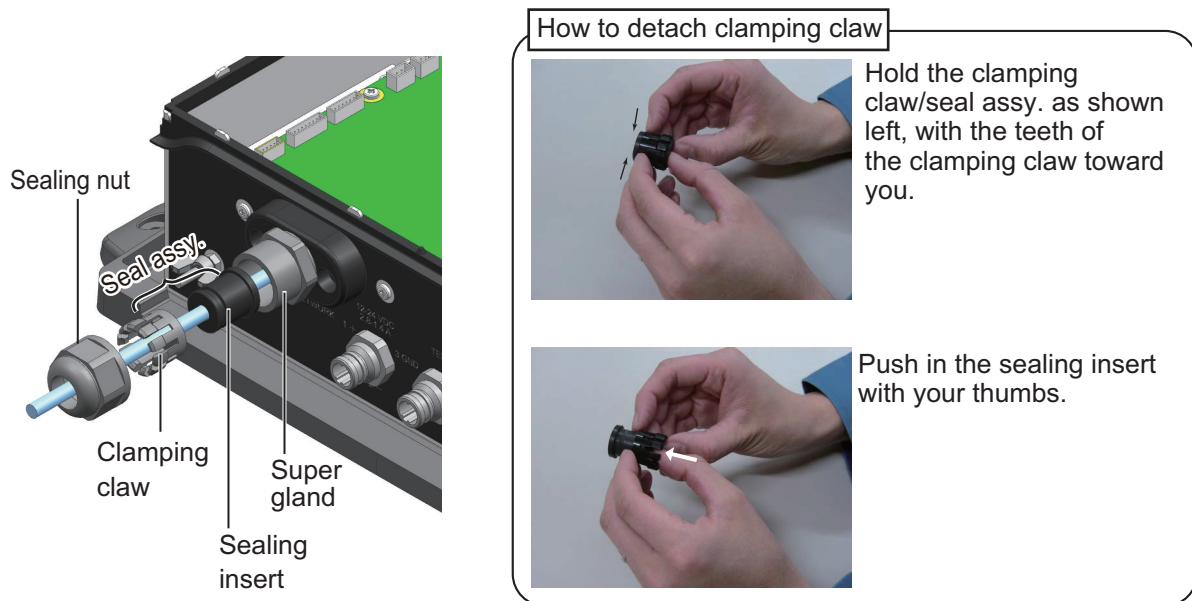

## 2. WIRING

3. Pass the sealing nut, clamping claw and sealing insert onto the LAN cable in the order shown in the figure below. Connect the cable to the LAN connector. (Note the orientation of the sealing insert when passing it onto the cable. Push the cable into the slit in the sealing insert.)

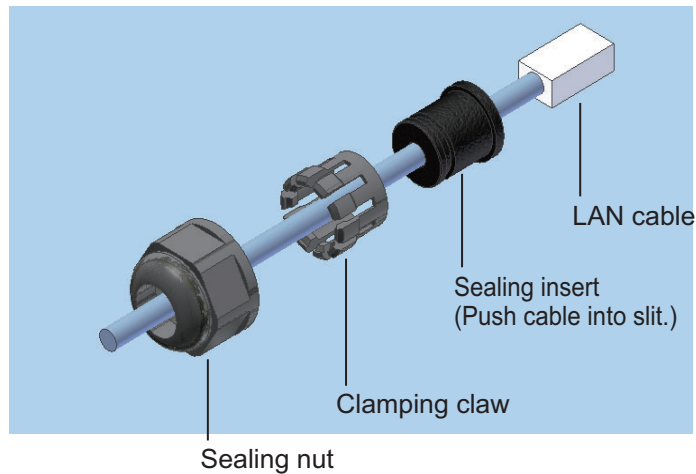

4. Set the sealing insert and clamping claw into the sealing nut then tighten the nut.
5. Tighten the sealing nut to fasten the LAN cable. The clearance between the sealing nut and the super gland shall be 3 mm. The torque for the sealing nut is 1.8 - 2.0 Nm.

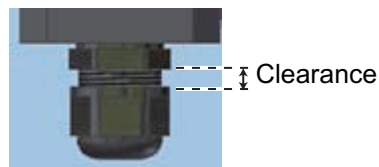

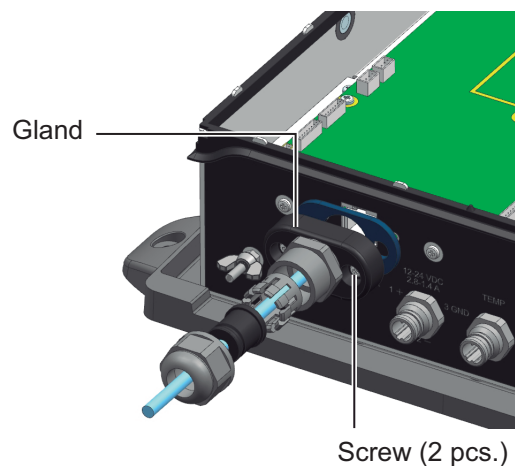

### **How to disconnect the LAN cable**

Loosen the two screws on the gland to access the cable's connector. A lock washer is fitted to the gland, so the screws cannot be unfastened completely.



# 3. INITIAL SETTINGS

WARNING



Do not open the equipment unless totally familiar with electrical circuits.

Only qualified personnel can work inside the equipment.

## 3.1 DIP Switch Setting

The DIP switch S2 sets up the system according to the equipment connected. In the default setting all switches (1-8) are OFF. The DIP switch S3 should not be adjusted; leave all switches in the OFF position.

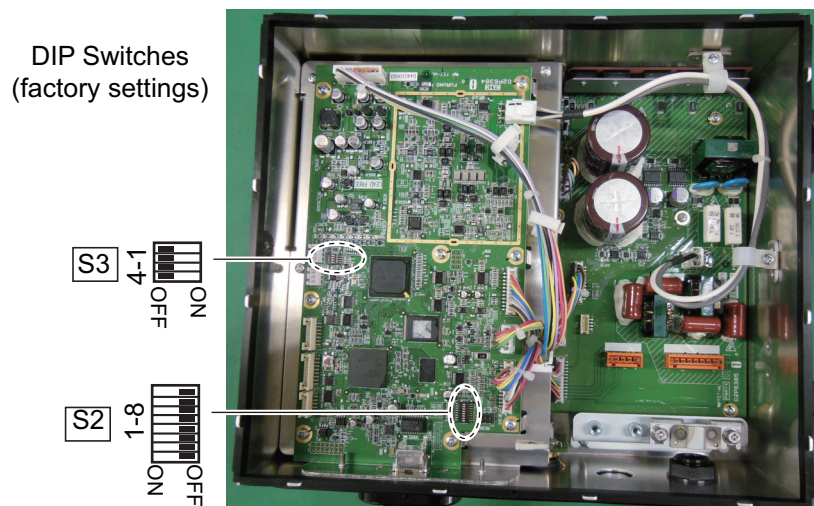

*DIP switch S2 description*

Switch No.	Function	Setting
1	IP mode	<b>OFF:</b> Fixed (static) IP address. Set the IP address with switch #2, referring to the table below. <b>ON:</b> Use IP address assigned by DHCP.
2	IP address no.	<b>OFF:</b> Set the #1 switch to OFF to set IP address. See the table on the next page for IP address assignment.
3	Restore default settings (other than LAN and transducer)	See section 4.3.
4	Restore ALL default settings	See section 4.3.
5 - 6	Keep these switches in the OFF position.	
7	TD-ID output ON/OFF	<b>OFF:</b> Output TD-ID. <b>ON:</b> Don't output TD-ID. Turn ON for NavNet 3D.
8	TD-ID format ON/OFF	<b>OFF:</b> TD-ID Format Code 2. <b>ON:</b> TD-ID Format Code 1.

### 3. INITIAL SETTINGS

#2	Host name	IP address
OFF	ES092002	172.031.092.002
ON	ES092003	172.031.092.003

After setting up the transducer at the DFF1-UHD, set the transducer type at the NavNet device. See respective Installation Manual for the procedure.

**Note:** DIP Switch S3 is for factory use. Do not change the settings.

## 3.2 Operation Check

For NavNet equipment, the DFF1-UHD is powered on/off from the ship's switchboard. The LED on the cover of the DFF1-UHD lights or blinks according to equipment state, as described in the table below.

### LED state and meaning

LED state	Meaning
Lit continuously	<ul style="list-style-type: none"> <li>Standby state. (If no signal is received via LAN for more than 10 minutes, the equipment automatically goes into standby to lessen power consumption.)</li> <li>Power on (20 seconds during initialization)</li> <li>IP address not set</li> </ul>
Blinking every two seconds	Normal operation
Blinking every 0.4 seconds	Transducer settings at NavNet device not properly set.

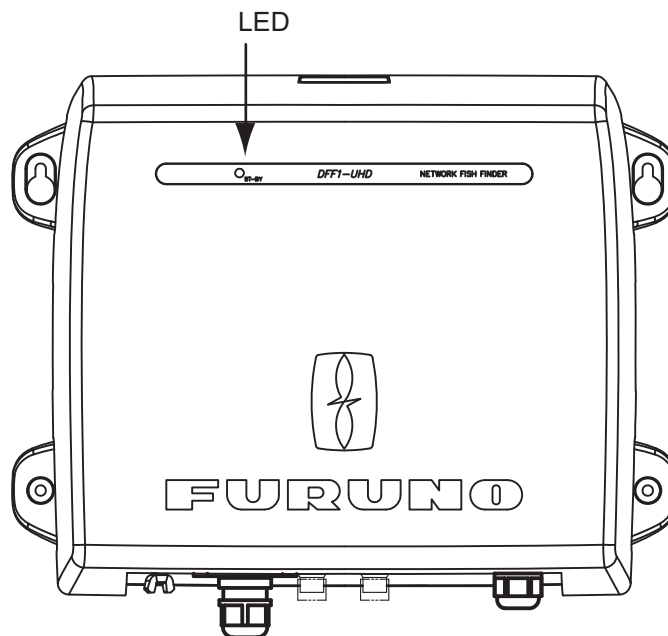

# 4. MAINTENANCE

 **WARNING**

 **ELECTRICAL SHOCK HAZARD**  
Do not open the equipment.

Only qualified personnel can work inside the equipment.

**NOTICE**

**Do not apply paint, anti-corrosive sealant or contact spray to coating or plastic parts of the equipment.**

Those items contain organic solvents that can damage coating and plastic parts, especially plastic connectors.

## 4.1 Maintenance

Regular maintenance is essential for good performance. Check the items listed in the table below at the suggested interval to help keep your equipment in good shape for years to come.

Item	Check point, action	Check interval
Transducer cable	Check that cable is tightly fastened and is not damaged. Refasten if necessary. Replace if damaged.	Once a month
Power cable, sensor cable	Check that these cables are tightly fastened and not damaged. Refasten if necessary. Replace if damaged.	Once a month
Ground terminal, ground wire	Check for corrosion. Clean if necessary. Replace wire if damaged.	Once a month
Power supply voltage	Check voltage. If out of rating correct problem.	Once a month
Cleaning the network fish finder's cabinet	Dust or dirt on the cabinet may be removed with a dry cloth. Do not use chemical-based cleaners to clean the cabinet; they can remove markings and damage the cabinet.	Once a month
Transducer	Marine life on the transducer face will result in a gradual decrease in sensitivity. Check the transducer face for cleanliness each time the boat is removed from the water. Carefully remove any marine life with a piece of wood or fine-grade sandpaper.	When vessel is removed from the water

## 4.2 How to Replace the Fuse

The 5A fuse (Type: FGBO-A 125V 5A PBF, Code No. 000-155-853-10) in the snap-in fuse holder on the power cable protects the equipment from equipment fault and reverse polarity of the power supply. If the equipment cannot be powered, the fuse may have blown. Find out the cause for the blown fuse before replacing it. If the fuse blows again after replacement, contact a FURUNO agent or dealer for instructions.

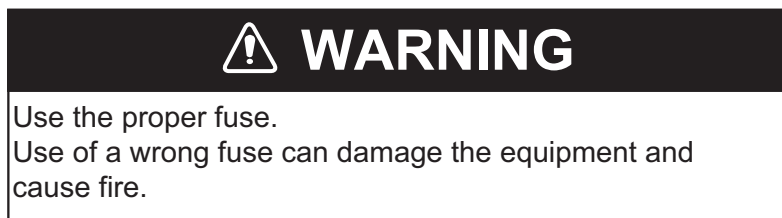

## 4.3 How to Restore Default Settings

This procedure restores all default sounder settings on the NavNet series device. You can restore all default settings or restore those other than transducer and LAN. This procedure should only be performed by a suitably qualified FURUNO technician.

1. Disconnect the power and LAN cables from the DFF1-UHD.
2. Open the outer cover and shield cover. Turn on the #3 or #4 switch of DIP Switch S2 as applicable.  
#3: Restore default settings other than LAN and transducer.  
#4: Restore all default settings. Use this when changing transducers.
3. Connect the power cable to the DFF1-UHD, and turn on the power at the ship's switchboard.
4. The LED blinks (every 0.4 seconds) when default settings are completely restored.
5. Close the shield cover and outer cover.
6. Set up the transducer at the NavNet equipment.

# APPX. 1 JIS CABLE GUIDE

Cables listed in the manual are usually shown as Japanese Industrial Standard (JIS). Use the following guide to locate an equivalent cable locally.

JIS cable names may have up to 6 alphabetical characters, followed by a dash and a numerical value (example: DPYC-2.5).

For core types D and T, the numerical designation indicates the *cross-sectional Area (mm<sup>2</sup>)* of the core wire(s) in the cable.

For core types M and TT, the numerical designation indicates the *number of core wires* in the cable.

## 1. Core Type

D: Double core power line

T: Triple core power line

M: Multi core

TT: Twisted pair communications  
(1Q=quad cable)

## 2. Insulation Type

P: Ethylene Propylene Rubber

## 3. Sheath Type

Y: PVC (Vinyl)

## 4. Armor Type

C: Steel

## 5. Sheath Type

Y: Anticorrosive vinyl sheath

## 6. Shielding Type

SLA: All cores in one shield, plastic tape w/aluminum tape

-SLA: Individually shielded cores, plastic tape w/aluminum tape



DPYC



TPYC

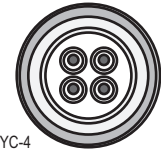

MPYC-4



TTYCSLA-4

EX: <sup>1</sup> <sup>3</sup> <sup>4</sup> <sup>5</sup> <sup>6</sup> **TTYCSLA** - **4**  
 Designation type | # of twisted pairs

<sup>1</sup> <sup>2</sup> <sup>3</sup> <sup>4</sup> **MPYC** - **4**  
 Designation type | # of cores

The following reference table lists gives the measurements of JIS cables commonly used with Furuno products:

Type	Area	Core Diameter	Cable Diameter	Type	Area	Core Diameter	Cable Diameter
DPYC-1.5	1.5mm <sup>2</sup>	1.56mm	11.7mm	TTYCSLA-1	0.75mm <sup>2</sup>	1.11mm	9.4mm
DPYC-2.5	2.5mm <sup>2</sup>	2.01mm	12.8mm	TTYCSLA-1T	0.75mm <sup>2</sup>	1.11mm	10.1mm
DPYC-4	4.0mm <sup>2</sup>	2.55mm	13.9mm	TTYCSLA-1Q	0.75mm <sup>2</sup>	1.11mm	10.8mm
DPYC-6	6.0mm <sup>2</sup>	3.12mm	15.2mm	TTYCSLA-4	0.75mm <sup>2</sup>	1.11mm	15.7mm
DPYC-10	10.0mm <sup>2</sup>	4.05mm	17.1mm	TTYCY-1	0.75mm <sup>2</sup>	1.11mm	11.0mm
DPYCY-1.5	1.5mm <sup>2</sup>	1.56mm	13.7mm	TTYCY-1T	0.75mm <sup>2</sup>	1.11mm	11.7mm
DPYCY-2.5	2.5mm <sup>2</sup>	2.01mm	14.8mm	TTYCY-1Q	0.75mm <sup>2</sup>	1.11mm	12.6mm
DPYCY-4	4.0mm <sup>2</sup>	2.55mm	15.9mm	TTYCY-4	0.75mm <sup>2</sup>	1.11mm	17.7mm
MPYC-2	1.0mm <sup>2</sup>	1.29mm	10.0mm	TTYCY-4SLA	0.75mm <sup>2</sup>	1.11mm	19.5mm
MPYC-4	1.0mm <sup>2</sup>	1.29mm	11.2mm	TTYCYSLA-1	0.75mm <sup>2</sup>	1.11mm	11.2mm
MPYC-7	1.0mm <sup>2</sup>	1.29mm	13.2mm	TTYCYSLA-4	0.75mm <sup>2</sup>	1.11mm	17.9mm
MPYC-12	1.0mm <sup>2</sup>	1.29mm	16.8mm	TTPYCSLA-1	0.75mm <sup>2</sup>	1.11mm	9.2mm
TPYC-1.5	1.5mm <sup>2</sup>	1.56mm	12.5mm	TTPYCSLA-1T	0.75mm <sup>2</sup>	1.11mm	9.8mm
TPYC-2.5	2.5mm <sup>2</sup>	2.01mm	13.5mm	TTPYCSLA-1Q	0.75mm <sup>2</sup>	1.11mm	10.5mm
TPYC-4	4.0mm <sup>2</sup>	2.55mm	14.7mm	TTPYCSLA-4	0.75mm <sup>2</sup>	1.11mm	15.3mm
TPYCY-1.5	1.5mm <sup>2</sup>	1.56mm	14.5mm				
TPYCY-2.5	2.5mm <sup>2</sup>	2.01mm	15.5mm				
TPYCY-4	4.0mm <sup>2</sup>	2.55mm	16.9mm				

# APPX. 2 INSTALLATION OF TRANSDUCERS

This appendix provides a copy of the installation instructions and Installation supplement for the AIRMAR transducers.

## OWNER'S GUIDE & INSTALLATION INSTRUCTIONS

### Thru-Hull *with Stem* Depth Transducer

*with Temperature Sensor*

Models: B45, B258, B260, B265LH, B265LM, B271W,  
B275LH-W, SS258, SS260, SS270W, SS505

U.S. Patent No. 7,369,45; 8,582,393. UK Patent No. 2 414 077

01/10/14

17-008-05 rev. 16

**Follow the precautions below for optimal product performance and to reduce the risk of property damage, personal injury, and/or death.**

**WARNING:** A High-Performance Fairing must be installed following the installation instructions that accompany the fairing. A High-Performance Fairing requires an anti-rotation bolt to keep the fairing from turning while the boat is underway.

**WARNING:** Always wear safety goggles and a dust mask when installing.

**WARNING:** Immediately check for leaks when the boat is placed in the water. Do not leave the boat unchecked for more than three hours. Even a small leak may allow considerable water to accumulate.

**CAUTION: CHIRP transducer**—Always operate the transducer in water. Operating in air will allow the transducer to overheat resulting in failure.

**CAUTION: Bronze transducer**—Never mount in a metal hull, because electrolytic corrosion will occur.

**CAUTION: Stainless steel housing in a metal hull** requires using a Fairing Kit to isolate the stainless steel transducer from the metal hull. Failure to do so will cause electrolytic corrosion.

**CAUTION:** Never install a metal transducer on a vessel with a positive ground system.

**CAUTION:** Never pull, carry, or hold the transducer by the cable as this may sever internal connections.

**CAUTION:** Never strike the transducer.

**CAUTION:** Never use solvents. Cleaner, fuel, sealant, paint, and other products may contain solvents that can damage plastic parts, especially the transducer's face.

**IMPORTANT:** Read the instructions completely before proceeding with the installation. These instructions supersede any other instructions in your instrument manual if they differ.

### Applications

- **Bronze** transducer recommended for fiberglass or wood hull only.
- **Stainless steel** transducer compatible with all hull materials. Recommended for aluminum hulls to prevent electrolytic corrosion provided the stainless steel transducer is isolated from the metal hull.

Record the information found on the cable tag for future reference.

Part No. \_\_\_\_\_ Date \_\_\_\_\_ Frequency \_\_\_\_\_ kHz

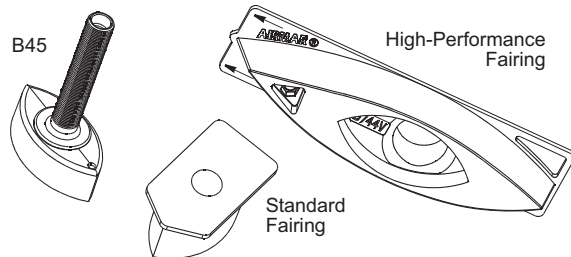

### Identify Your Model

The model name is printed on the cable tag.

### Tools & Materials

Safety goggles

Dust mask

Electric drill

Drill bits and hole saws:

Pilot hole	3mm or 1/8"
B45, SS505	22mm or 7/8"
B258, B271W, SS258	30mm or 1-3/16"
B260, B265LH/LM, B275LH-W, SS260, SS270W	33mm or 1-5/16"

Sandpaper

Mild household detergent or weak solvent (such as alcohol)

File (installation in a metal hull)

Angle finder (installation with a fairing)

Band saw (installation with a fairing)

Rasp or power tool (installation with a fairing)

Marine sealant (suitable for below waterline)

Slip-joint pliers

Grommet(s) (some installations)

Cable ties

Water-based anti-fouling paint (**mandatory in salt water**)

Installation in a cored fiberglass hull: (see page 4)

Drill bits and hole saws for hull interior:

B45, SS505	35mm or 1-3/8"
B258, B271W, SS258	40mm, 41mm, or 1-5/8"
B260, B265LH/LM, B275LH-W, SS260, SS270W	42mm or 1-5/8"

Cylinder, wax, tape, and casting epoxy

### About Fairings

Most vessels have some deadrise angle at the mounting location. If the transducer is mounted directly to the hull, the sound beam will be tilted to the side at the same angle as the deadrise. A fairing is strongly recommended if the deadrise angle exceeds 10°. Made of a high-impact polymer with an integrated cutting guide, an Airmar fairing is safer and easier to cut with a band saw and shape with hand tools than custom fairings.

- Orients the sound beam straight down by mounting the transducer parallel to the water surface.
- Mounts the transducer deeper in the water for clean flow under the transducer's face.
- **Airmar High-Performance Fairing** has a long streamlined shape, directing water around the transducer to minimize drag. Performance is excellent above 15kn (18MPH). (To order see "Replacement Parts" on page 4.)



## APPX. 2 INSTALLATION OF TRANSDUCERS

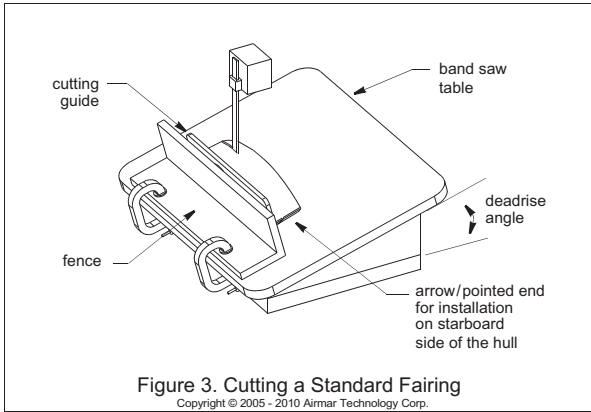

- Tilt the band saw table to the measured angle and secure the cutting fence (see Figure 3).
- Place the fairing on the table, so the cutting guide rests against the fence. The arrow/pointed end will be pointing *toward* you for installation on the starboard side of the boat or *away* from you for installation on the port side (see Figure 4).
- Adjust the cutting fence, so the fairing will be cut in about two equal parts (see Figure 3). *The section that will become the fairing must be between 6–12mm (1/4–1/2") at its thinnest dimension (see Figure 2).*
- Recheck steps 1 through 4. Then cut the fairing.
- Shape the fairing to the hull as precisely as possible with a rasp or power tool.
- Use the remaining section of the fairing with the cutting guide for the backing block.

### Bedding

**CAUTION:** Be sure all surfaces to be bedded are clean and dry.

- Remove the hull nut (see Figure 5).
- Thread the transducer cable through the fairing (if used).
- Apply a 2mm (1/16") thick layer of marine sealant to the surface of the transducer that will contact the hull/fairing and up the stem. The sealant must extend 6mm (1/4") higher than the combined thickness of the hull, fairing and backing block (if used), and the hull nut. This will ensure there is marine sealant in the threads to seal the hull and hold the hull nut securely in place.

**Stainless steel transducer/stem in a metal hull**—Slide the isolation sleeve over the bedded transducer stem as far down as possible (see Figure 2). Apply a 2mm (1/16") thick layer of the marine sealant to the outside of the sleeve.

- Apply a 2mm (1/16") thick layer of marine sealant to the following surfaces (see Figure 5):
  - Fairing that will contact the hull
  - Backing block that will contact the hull interior
  - Hull nut that will contact the hull/backing block
- Standard Fairing**—Seat the transducer firmly in/against the fairing with a pushing twisting motion. Be sure the button on the fairing mates with the recess in the transducer housing.

### Installing

- From outside the hull, thread the cable through the mounting hole. Then push the stem of the transducer through the hole using a twisting motion to squeeze out excess sealant. *Take care to align the transducer with the blunt/button/arrow end*

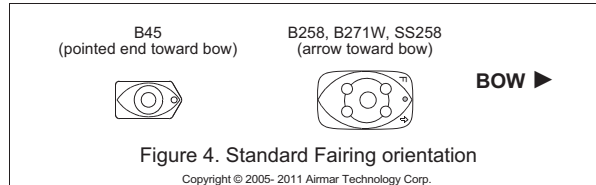

*facing forward toward the bow. The long side must be parallel to the centerline of the boat (see Figure 4).*

**Stainless steel transducer in a metal hull** —Be sure the isolation sleeve is between the transducer stem and the hull (see Figure 2). However, the isolation sleeve must be below the hull nut to prevent the sleeve from interfering with tightening the nut.

- From inside the hull, slide the backing block (if installing with a fairing) and the hull nut onto the cable. Seat any backing block against the hull, being sure the arrow end faces forward toward the bow. Screw the hull nut in place and tighten it with slip-joint pliers (see Figures 4 and 5).

**Cored fiberglass hull**—Do not over-tighten, crushing the hull.

**Wood hull**—Allow for the wood to swell before tightening the nut.

- Remove any excess marine sealant on the outside of the hull/fairing to ensure smooth water flow under the transducer.

### Cable Routing & Connecting

**CAUTION:** If the sensor came with a connector, do not remove it to ease cable routing. If the cable must be cut and spliced, use Airmar's splash-proof Junction Box No. 33-035 and follow the instructions supplied. Removing the waterproof connector or cutting the cable, except when using a water-tight junction box, will void the sensor warranty.

- Route the cable to the instrument being careful not to tear the cable jacket when passing it through the bulkhead(s) and other parts of the boat. Use grommet(s) to prevent chafing. To reduce electrical interference, separate the transducer cable from other electrical wiring and the engine. Coil any excess cable and secure it in place with cable ties to prevent damage.
- Refer to the instrument owner's manual to connect the transducer to the instrument.

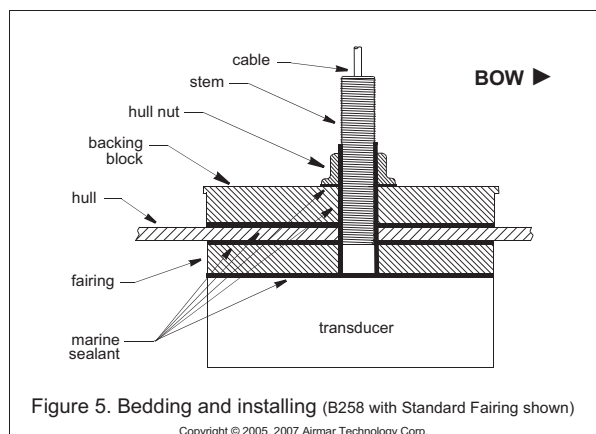

**Checking for Leaks**

When the boat is placed in the water, **immediately** check around the transducer for leaks. Note that very small leaks may not be readily observed. Do not leave the boat in the water for more than 3 hours before checking it again. If there is a small leak, there may be considerable bilge water accumulation after 24 hours. If a leak is observed, repeat "Bedding" and "Installing" **immediately** (see page 3).

**Installation in a Cored Fiberglass Hull**

The core (wood or foam) must be cut and sealed carefully. The core must be protected from water seepage, and the hull must be reinforced to prevent it from crushing under the hull nut, allowing the transducer to become loose.

**CAUTION:** Completely seal the hull to prevent water seepage into the core.

1. Drill a 3mm or 1/8" pilot hole perpendicular to the waterline from inside the hull (see Figure 6). If there is a rib, strut, or other hull irregularity near the selected mounting location, drill from the outside. (If the hole is drilled in the wrong location, drill a second hole in a better location. Apply masking tape to the outside of the hull over the incorrect hole and fill it with epoxy.)
2. Using the appropriate size drill bit, cut a hole from outside the hull through the *outer* skin only. *Be sure to hold the drill plumb, so the hole will be perpendicular to the water surface.*
3. The optimal interior hole diameter is affected by the hull's thickness and deadrise angle. It must be large enough in diameter to allow the core to be completely sealed. Using the appropriate size drill bit for the hull interior, cut through the *inner* skin and most of the core from inside the hull keeping the drill perpendicular to the hull. The core material can be very soft. Apply only light pressure to the drill bit after cutting through the *inner* skin to avoid accidentally cutting the *outer* skin.
4. Remove the plug of core material so the *inside* of the outer skin and the inner core of the hull is fully exposed. Sand and clean the inner skin, core, and the outer skin around the hole.

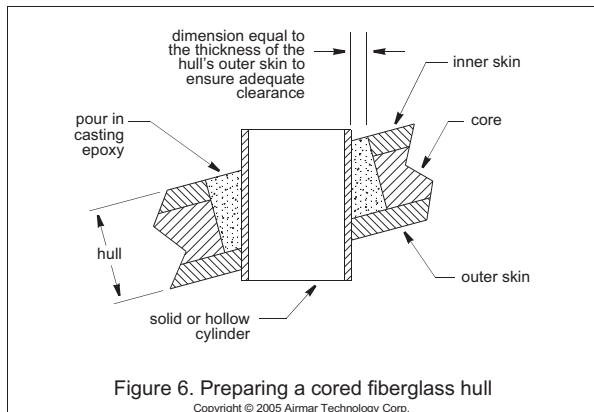

5. Coat a hollow or solid cylinder of the correct diameter with wax and tape it in place. Fill the gap between the cylinder and hull with casting epoxy. After the epoxy has set, remove the cylinder.
6. Sand and clean the area around the hole, inside and outside, to ensure that the sealant will adhere properly to the hull. If there is any petroleum residue inside the hull, remove it with either mild household detergent or a weak solvent (alcohol) before sanding.
7. Proceed with "Cutting the Standard Fairing" on page 2.

**Anti-fouling Paint**

Surfaces exposed to salt water must be coated with anti-fouling paint. Use **water-based** anti-fouling paint only. Never use ketone-based paint since ketones can attack many plastics possibly damaging the transducer. Reapply anti-fouling paint every 6 months or at the beginning of each boating season.

**Maintenance, Parts & Replacement**

**Cleaning**

Aquatic growth can accumulate rapidly on the transducer's surface reducing its performance within weeks. Clean the surface with a Scotch-Brite® scour pad and mild household detergent taking care to avoid making scratches. If the fouling is severe, lightly wet sand with fine grade wet/dry paper.

**Replacement Transducer & Parts**

The information needed to order a replacement transducer is printed on the cable tag. Do not remove this tag. When ordering, specify the part number, date, and frequency in kHz. For convenient reference, record this information on the top of page 1.

Lost, broken, and worn parts should be replaced immediately.

Model	Hull Nut	Fairing Type	Fairing
B45	02-031-3	Standard	33-351-01
		High-Performance	33-509-01
B258, B271W	02-222-03	Standard	33-226-01
		High-Performance	33-523-01
B260	02-036-2	High-Performance	33-391-01
B265LH/LM, B275LH-W	02-036-2	High-Performance	33-391-01
SS258	02-539-01	Standard	33-226-01
		High-Performance	33-523-01
SS260	02-036-03	High-Performance	33-391-01
SS270W	02-036-03	High-Performance	33-391-01
SS505	02-111-01	High-Performance	33-355-01

Obtain parts from your instrument manufacturer or marine dealer.

Gemeco (USA)	Tel: 803-693-0777 Fax: 803-693-0477 email: sales@gemeco.com
Airmar EMEA (Europe, Middle East, Africa)	Tel: +33.(0)2.23.52.06.48 Fax: +33.(0)2.23.52.06.49 email: sales@airmar-emea.com



35 Meadowbrook Drive, Milford, New Hampshire 03055-4613, USA  
•www.airmar.com

# AVOID OVERHEATING

## Installation Supplement: *Chirp Transducers*



**CAUTION:** Follow the instructions that came with your transducer. To install a Chirp transducer in a way other than intended by the manufacturer may lead to the transducer overheating, resulting in transducer failure.

Due to the nature of Chirp technology, Chirp transducers generate more heat than traditional tone-burst transducers operating at the same frequency. Chirp transducers have heat sinks in their construction to dissipate heat. Airmar's Chirp transducers have been designed to be installed in specific ways according to the number and placement of these heat sinks.

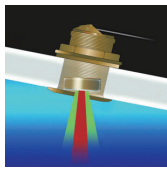

**Thru-Hull Mount: Low-Profile**

Models: B75L/M/H, B150M, B175L/M/H, B175HW, SS75L/M/H, SS175L/M/H, SS175HW

Transducer is installed in a hole drilled through the hull at a cool location away from the engine compartment. During operation, the active face of the transducer is in contact with water.

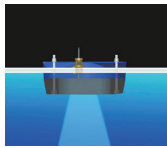

**Thru-Hull Mount: External, Stem**

Models: B265LH/LM, B275LHW, B285HW, B285M, B765LH/LM, B785M, M188LH, R109LH/LM, R109LHW, R409LWM, R509LH/LM, R509LHW

Transducer is installed entirely outside of the hull. A stem or stuffing tube hole is drilled through the hull for the transducer cable. The active face and sides of the transducer are immersed in water.



**In-Hull Mount**

Models: M135M, M265LH/LM, M285HW, P75M, P95M, P155M, R111LH/LM, R599LH/LM

Transducer is installed within a wetbox/yellow plastic tank affixed inside the hull at a cool location. It must be away from the engine compartment and other hot places. No holes are drilled in the hull, however this installation is suitable for a solid fiberglass hull only. The active face and the sides of the transducer are immersed in propylene glycol (non-toxic marine/RV anti-freeze).

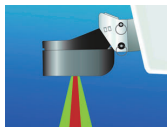

**Transom Mount**

Models: IC-TM90M, TM150M, TM165HW, TM185HW, TM185M, TM265LH/LM, TM275LHW

Transducer is bolted to the outside of the boat on the transom. During operation, the active face and sides of the transducer are immersed in water.

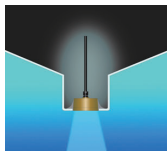

**Keel Mount**

Models: CM599L, CM599LH/LM, CM599LHW, PM111LH/LM, PM111LHW, PM265LH/LM, PM275LHW, PM411LWM

Transducer is fiberglassed into the keel at a cool location away from the engine compartment. The active face of the transducer is flush with the outside of the hull and in contact with water.

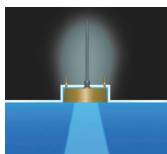

**Pocket Mount**

Models: CM599L, CM599LH/LM, CM599LHW, PM111LH/LM, PM111LHW, PM265LH/LM, PM275LHW, PM411LWM

Transducer is bolted into a fiberglass cavity formed in the hull at a cool location away from the engine compartment. The active face of the transducer is flush with the outside of the hull and in contact with water.

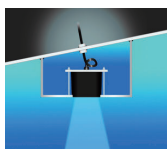

**Welded-tank Mount**

Models: CM265LH/LM, CM275LHW, CM599LH/LM, CM599LHW

Transducer is installed within a water-filled, welded tank outside of the hull. A stem or stuffing tube hole is drilled through the hull for the transducer cable. The active face and sides of the transducer are immersed in water.

# APPX. 3 INSTALLATION OF TEMPERATURE SENSORS

The installation instructions in this chapter are copied from the manufacturer's (AIRMAR® Technology Corporation) installation guide, which is included with your sensor. The model numbers mentioned within the documentation should be read as follows:

- T42 → T-04MSB
- T80 → T-04MTB

## OWNER'S GUIDE & INSTALLATION INSTRUCTIONS

### Thru-Hull, Analog High-Precision Temperature Sensor

Model T42

Record the information found on the cable tag for future reference.

Part No. \_\_\_\_\_ Date \_\_\_\_\_

17-437-02 rev. 01  
05/28/14

**Follow the precautions below for optimal product performance and to reduce the risk of property damage, personal injury, and/or death.**

**WARNING:** Always wear safety goggles and a dust mask when installing.

**WARNING:** Immediately check for leaks when the boat is placed in the water. Do not leave the boat unchecked for more than three hours. Even a small leak can allow considerable water to accumulate.

**CAUTION:** Never install a bronze sensor in a metal hull because electrolytic corrosion will occur.

**CAUTION:** Never install a metal sensor on a vessel with a positive ground system.

**CAUTION:** Never pull, carry, or hold the sensor by its cable; this may sever internal connections.

**CAUTION:** Never use solvents. Cleaner, fuel, sealant, paint, and other products may contain solvents that can damage plastic parts, especially the sensor's face.

**IMPORTANT:** Read the instructions completely before proceeding with the installation. These instructions supersede any other instructions in your instrument manual if they differ.

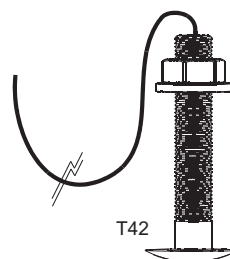

### Tools & Materials

- Safety goggles
- Dust mask
- Electric drill
- Drill bit/hole saw/spade bit:
  - Pilot hole 3mm or 1/8"
  - T42 22mm or 7/8"
- Sandpaper
- Mild household detergent or weak solvent (alcohol)
- Marine sealant (suitable for below waterline)
- Slip-joint pliers
- Installation in a cored fiberglass hull (see page 2)
  - Hole saw for hull interior: 30mm or 1-1/4"
  - Cylinder, wax, tape, and casting epoxy
- Water-based anti-fouling paint (**mandatory in salt water**)

### Sensor Installation

#### Hole Drilling

**Cored fiberglass hull** — Follow separate instructions on page 2.

1. Drill a 3mm or 1/8" pilot hole from inside the hull. If there is a rib, strut, or other hull irregularity near the selected mounting location, drill from the outside.
2. Using the appropriate drill bit, cut a hole perpendicular to the hull from outside the boat.
3. Sand and clean the area around the hole, inside and outside, to ensure that the marine sealant will adhere properly to the hull. If there is any petroleum residue inside the hull, remove it with either mild household detergent or a weak solvent (alcohol) before sanding.

### Applications

- Bronze sensor recommended for fiberglass or wood hull only.
- The hull must be a minimum of 8mm (5/16") thick at the mounting location.

### Mounting Location

Choose a location where the temperature sensor will be in contact with the water at all times.

## APPX. 3 INSTALLATION OF TEMPERATURE SENSORS

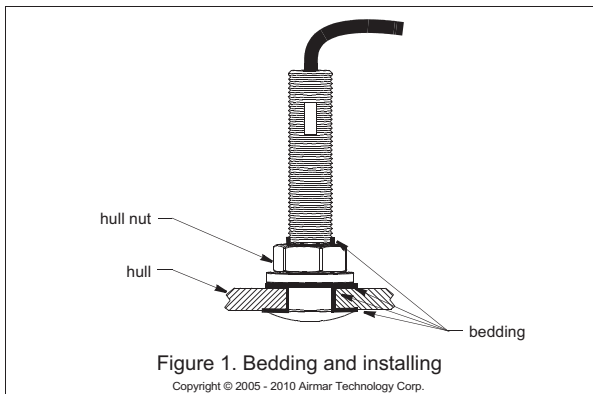

### Bedding

**CAUTION:** Be sure all surfaces to be bedded are clean and dry.

1. Remove the hull nut (see Figure 1).
2. Apply a 2 mm (1/16") thick layer of marine sealant around the flange of the sensor that will contact the hull and up the stem. The sealant must extend 6mm (1/4") higher than the combined thickness of the hull and the hull nut. This will ensure that there is marine sealant in the threads to seal the hull and hold the hull nut securely in place.
3. Apply a 2 mm (1/16") thick layer of marine sealant to the flange of the hull nut that will contact the hull.

### Installing

1. From outside the hull, thread the cable through the mounting hole.
2. Push the sensor into the mounting hole using a twisting motion to squeeze out excess marine sealant (see Figure 1).
3. From inside the hull, slide the hull nut onto the cable. Screw the hull nut in place. Tighten it with slip-joint pliers.  
**Cored fiberglass hull**—Do not over tighten, crushing the hull.  
**Wood hull**—Allow for the wood to swell before tightening.
4. Remove any excess marine sealant on the outside of the hull to ensure smooth water flow over the sensor.

### Checking for Leaks

When the boat is placed in the water, **immediately** check around the thru-hull sensor for leaks. Note that very small leaks may not be readily observed. Do not to leave the boat in the water for more than 3 hours before checking it again. If there is a small leak, there may be considerable bilge water accumulation after 24 hours. If a leak is observed, repeat "Bedding" and "Installing" **immediately** (see page 2).

### Cable Routing & Connecting

**CAUTION:** If the sensor came with a connector, do not remove it to ease cable routing. If the cable must be cut and spliced, use Airmar's splash-proof Junction Box No. 33-035 and follow the instructions supplied. Removing the waterproof connector or cutting the cable, except when using a water-tight junction box, will void the sensor warranty.

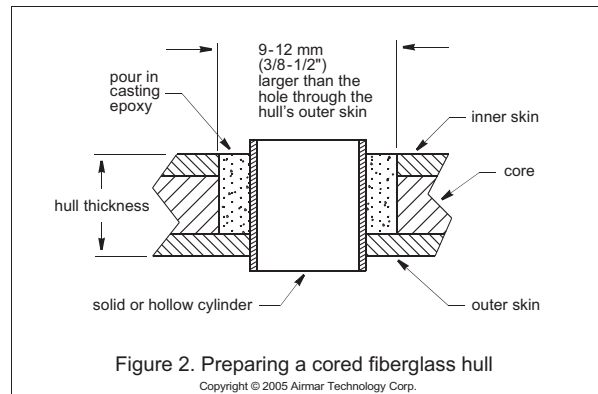

1. Route the cable to the instrument being careful not to tear the cable jacket when passing it through the bulkhead(s) and other parts of the boat. Use grommet(s) to prevent chafing. To reduce electrical interference, separate the transducer cable from other electrical wiring and the engine. Coil any excess cable and secure it in place with cable ties to prevent damage.
2. Refer to the instrument owner's manual to connect the transducer to the instrument.

### Installation in a Cored Fiberglass Hull

The core (wood or foam) must be cut and sealed carefully. The core must be protected from water seepage, and the hull must be reinforced to prevent it from crushing under the hull nut allowing the sensor to become loose.

**CAUTION:** Completely seal the hull to prevent water seepage into the core.

1. Drill a 3mm or 1/8" pilot hole from inside the hull. If there is a rib, strut, or other hull irregularity near the selected mounting location, drill from the outside. (If the hole is drilled in the wrong location, drill a second hole in a better location. Apply masking tape to the outside of the hull over the incorrect hole and fill it with epoxy.)
2. Using the 21 mm or 7/8" drill bit, cut a hole from outside the hull through the *outer* skin only (see Figure 2).
3. From inside the hull using the 30mm or 1-1/4" hole saw, cut through the *inner* skin and most of the core. The core material can be very soft. Apply only light pressure to the hole saw after cutting through the inner skin to avoid accidentally cutting the *outer* skin.
4. Remove the plug of core material so the *inside* of the outer skin and the inner core of the hull is fully exposed. Clean and sand the inner skin, core, and the outer skin around the hole.
5. Coat a hollow or solid cylinder of the correct diameter with wax and tape it in place. Fill the gap between the cylinder and hull with casting epoxy. After the epoxy has set, remove the cylinder.
6. Sand and clean the area around the hole, inside and outside, to ensure that the sealant will adhere properly to the hull. If there is any petroleum residue inside the hull, remove it with either mild household detergent or a weak solvent (alcohol) before sanding.
7. Proceed with "Bedding" and "Installing" (see page 2).



# OWNER'S GUIDE & INSTALLATION INSTRUCTIONS

## Surface Mount, Analog Temperature Sensor

Model T80

Record the information found on the cable tag for future reference.

Part No. \_\_\_\_\_ Date \_\_\_\_\_



05/28/14

17-584-01 rev. 01

**Follow the precautions below for optimal product performance and to reduce the risk of property damage, personal injury, and/or death.**

**WARNING:** Always wear safety goggles and a dust mask when installing.

**WARNING: Below the waterline mount**—When the boat is placed in the water, immediately check for leaks around the screws and any other holes drilled in the hull.

**CAUTION: Installation on a metal hull**—The stainless steel housing must be isolated from a metal hull to prevent electrolytic corrosion. Use marine sealant.

**CAUTION:** Never install a metal sensor on a vessel with a positive ground system.

**IMPORTANT:** Read the instructions completely before proceeding with the installation. These instructions supersede any other instructions in your instrument manual if they differ.

### Tools & Materials

- Safety goggles
- Dust mask
- Pencil
- Electric drill
- Drill bit/hole saw/spade bit:
  - Pilot holes 3 mm or 1/8"
  - Transom hole (some installations) 18 mm or 3/4"
- 2 Stainless steel, self-tapping screws 4 x 18 mm or #8 x 3/4"
- Marine sealant (suitable for below waterline)
- Screwdriver(s)
- Cable clamp(s) (some installations)
- Grommet(s) (some installations)
- Cable ties

### Installation

#### Mounting on the transom

**CAUTION:** Mount the sensor as close to the centerline (keel) of the boat as possible to ensure the sensor remains in the water when the boat is turning (see Figure 1).

**CAUTION: Fiberglass hull**—Minimize surface cracking by running the drill in reverse until the gelcoat is penetrated.

**CAUTION:** If the sensor came with a connector, do not remove it to ease cable routing. If the cable must be cut and spliced, use Airmar's splash-proof Junction Box No. 33-035 and follow the instructions provided. Removing the waterproof connector or cutting the cable, except when using a water-tight junction box, will void the sensor warranty.

### Applications

- Measures air or water temperature.
- Stainless steel sensor is compatible with all hull materials. Recommended for aluminum hulls to prevent electrolytic corrosion, provided the stainless steel sensor is isolated from the metal hull by using marine sealant.

### Mounting Location

The sensor can be mounted anywhere that you want to know the temperature. For example, you can mount the sensor on the transom, in the live well, or in the engine compartment.

If you are measuring water temperature, choose a location where the sensor will be in contact with the water at all times.

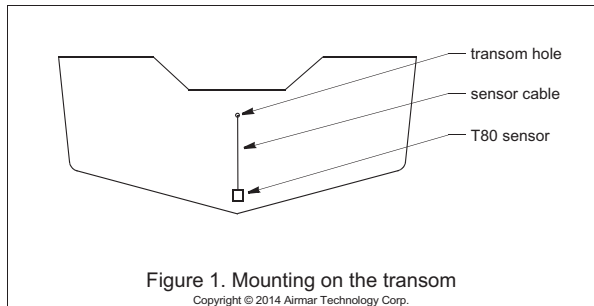

Figure 1. Mounting on the transom

Copyright © 2014 Airmar Technology Corp.

Mount the sensor near the centerline and close to the bottom of the transom.

Route the sensor cable over the transom, through a drain hole, or through a hole that you have drilled in the transom **above the waterline**.

1. Place the sensor against the hull and mark the position of the screw holes with a pencil.
2. Using a 3mm or 1/8" drill bit, drill pilot holes at the marked locations, 10mm (3/8") deep.
3. Apply marine sealant to the threads of the purchased screws to prevent water from seeping into the transom.
4. Screw the temperature sensor to the hull.
5. If a hole must be drilled through the transom, choose a location **well above the waterline**. Check for obstructions such as trim tabs, pumps, or wiring inside the hull. Mark the location with a pencil. Drill a hole through the transom using the appropriate size hole saw or spade bit (to accommodate the connector). Do NOT remove the connector.
6. Route the cable over or through the transom.
7. On the outside of the hull, secure the cable against the transom using a purchased cable clamp(s). Mark the position of the screw hole(s) with a pencil.
8. Using a 3mm or 1/8" drill bit, drill a pilot hole(s) at the marked locations, 10mm (3/8") deep.
9. Apply marine sealant to the threads of the screw(s) to prevent water from seeping into the transom.
10. Fasten the cable clamp(s) in place.
11. If a hole has been drilled through the transom, apply marine sealant to the space around the cable leading through the transom.

### Cable Routing & Connecting

1. Route the cable to the instrument, being careful not to tear the cable jacket when passing it through the bulkhead(s) and other parts of the boat. To reduce electrical interference, separate the sensor cable from other electrical wiring and sources of noise. Coil any excess cable and secure it in place with cable ties to prevent damage.
2. Refer to the instrument owner's manual to connect the sensor to the instrument.

### Replacement Sensor & Parts

The information needed to order a replacement sensor is printed on the cable tag. Do not remove this tag. When ordering, specify the part number and date. For convenient reference, record this information at the top of page one.

Obtain parts from your instrument manufacturer or marine dealer.

Gemeco  
(USA)

Tel: 803-693-0777  
Fax: 803-693-0477  
email: sales@gemeco.com

Airmar EMEA  
(Europe, Middle East, Africa)

Tel: +33.(0)2.23.52.06.48  
Fax: +33.(0)2.23.52.06.49  
email: sales@airmar-emea.com



35 Meadowbrook Drive, Milford, New Hampshire 03055-4613, USA  
•www.airmar.com

## **SPECIFICATIONS OF NETWORK FISH FINDER DFF1-UHD**

### **1 GENERAL**

- |     |                   |   |
|-----|-------------------|---|
| 1.1 | TX frequency      | Selected from 42 to 65 kHz or 130 to 250 kHz,<br>alternative transmission |
| 1.2 | Output power      | 1 kW nominal  |
| 1.3 | Amplifier type    | Straight amplifier (H/L gain switching available)                         |
| 1.4 | Transmitting rate | 3000 pulse/min. or less   |
| 1.5 | Depth range       | 2 to 1200 m   |
| 1.6 | Range shift       | 1200 m max.   |

### **2 INTERFACE**

- |     |                   |                                  |
|-----|-------------------|----------------------------------|
| 2.1 | Number of ports   |                                  |
|     | Network           | 1 port                           |
|     | Temp/speed sensor | 1 port                           |
|     | External KP       | 1 port (external KP kit: option) |
| 2.2 | Network method    | Ethernet 10Base-T/100Base-TX     |

### **3 POWER SUPPLY**

- |     |                           |  |
|-----|---------------------------|--|
| 3.1 | Network fish finder       | 12-24 VDC: 2.8-1.4 A                   |
| 3.2 | Rectifier (PR-62, option) | 100/110/220/230 VAC, 1 phase, 50/60 Hz |

### **4 ENVIRONMENTAL CONDITIONS**

- |     |                      |                      |
|-----|----------------------|----------------------|
| 4.1 | Ambient temperature  | -15°C to +55°C       |
| 4.2 | Relative humidity    | 93% or less at +40°C |
| 4.3 | Degree of protection | IP55                 |
| 4.4 | Vibration            | IEC 60945 Ed.4       |

### **5 UNIT COLOR**



- |     |                     |              |
|-----|---------------------|--------------|
| 5.1 | Network fish finder | N2.5 (fixed) |
|-----|---------------------|--------------|

# PACKING LIST

02GL-X-9855 -0 1/1

DFF1-UHD (IP55)

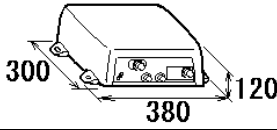
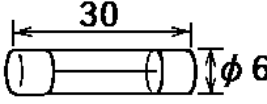
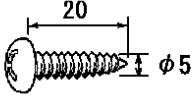
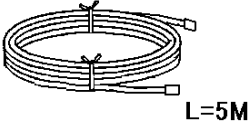
A-1

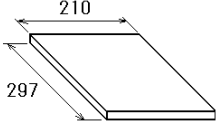
NAME	OUTLINE	DESCRIPTION/CODE No.	Q'TY
<b>ユニット UNIT</b>			
ネットワーク魚探 NETWORK FISH FINDER		DFF1-UHD	1
		000-026-834-00	
<b>予備品 SPARE PARTS</b>			
ヒューズ GLASS TUBE FUSE		FGB0-A 125V 5A PBF	2
		000-155-853-10	
<b>工事材料 INSTALLATION MATERIALS</b>			
+トラスタップ・ソネジ 1シユ SELF-TAPPING SCREW		5X20 SUS304	4
		000-162-608-10	
ケーブル(組品)LAN LAN CABLE ASSEMBLY		MOD-Z072-050+	1
		001-167-890-10	
ケーブル組品MJ CABLE ASSEMBLY		MJ-A3SPF0013-035C (5A)	1
		000-157-939-10	
<b>図書 DOCUMENT</b>			
取扱説明書 OPERATOR'S MANUAL		OM*-20400-*	1
		000-177-244-1* **	

コード番号末尾の[\*\*]は、選択品の代表コードを表します。  
CODE NUMBER ENDING WITH "\*\*" INDICATES THE CODE NUMBER OF REPRESENTATIVE MATERIAL.

型式/コード番号が2段の場合、下段より上段に代わる過渡期品であり、どちらかが入っています。なお、品質は変わりません。  
TWO TYPES AND CODES MAY BE LISTED FOR AN ITEM. THE LOWER PRODUCT MAY BE SHIPPED IN PLACE OF THE UPPER PRODUCT. QUALITY IS THE SAME.

(略図の寸法は、参考値です。DIMENSIONS IN DRAWING FOR REFERENCE ONLY.)

表1 TABLE 1

寸法区分 (mm) DIMENSION	公差 (mm) TOLERANCE
L ≤ 50	±1.5
50 < L ≤ 100	±2.5
100 < L ≤ 500	±3

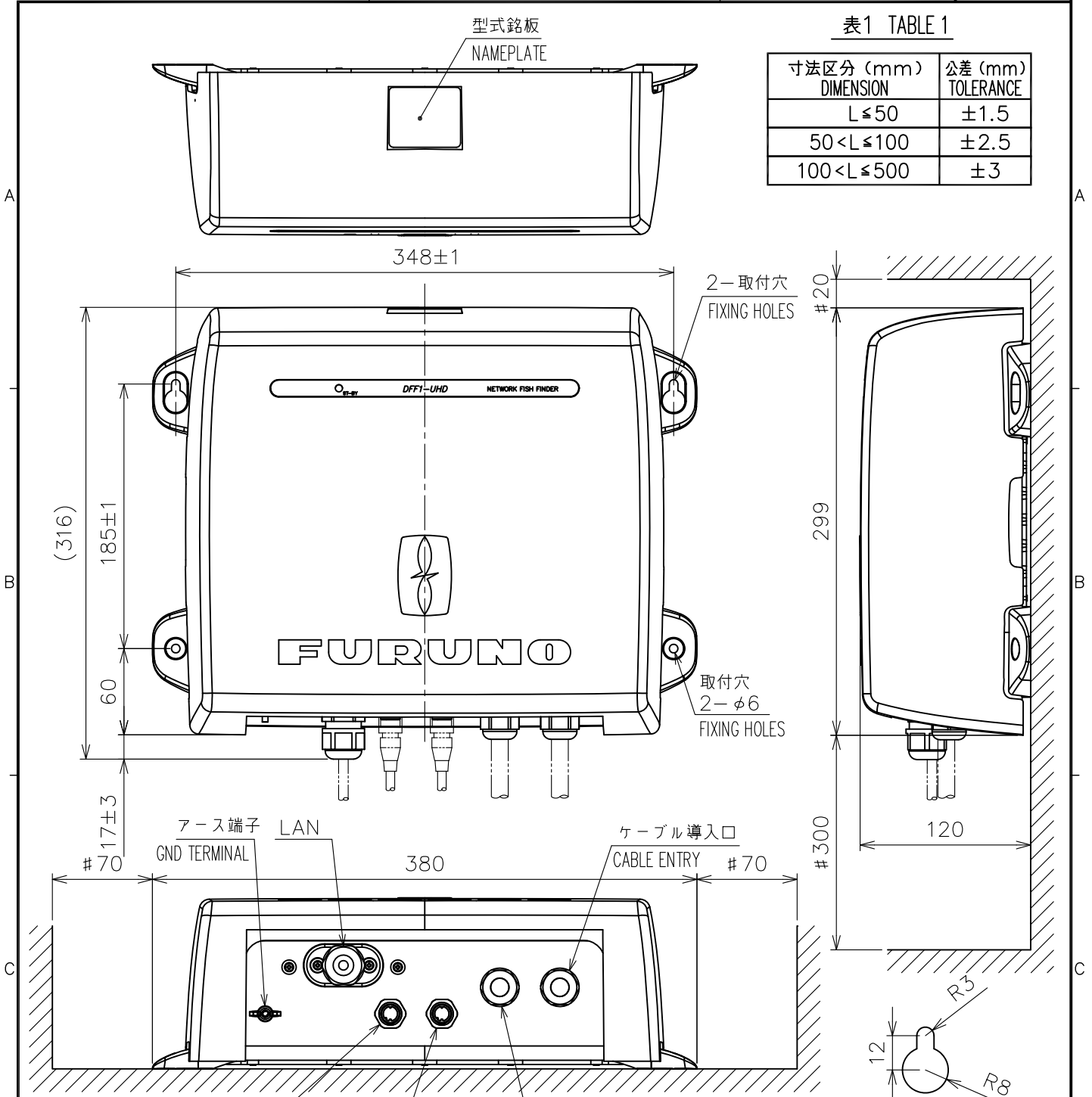

- 注記
- 1) 指定外の寸法公差は表1による。
  - 2) #印寸法は最小サービス空間寸法とする。
  - 3) 取付用ネジはトラスタップピンネジ呼び径5×20を使用のこと。
  - 4) 壁掛時、ケーブルは下方のみとする。

- NOTE
1. TABLE 1 INDICATES TOLERANCE OF DIMENSIONS WHICH IS NOT SPECIFIED.
  2. #: MINIMUM SERVICE CLEARANCE.
  3. USE TAPPING SCREWS  $\phi 5 \times 20$  FOR FIXING THE UNIT.
  4. FACE THE CABLES DOWNWARD FOR BULKHEAD MOUNTING.

DRAWN	26/Aug/2014 I.YAMASAKI	TITLE	DFF1-UHD
CHECKED	26/Aug/2014 H.MAKI	名称	ネットワーク魚探
APPROVED	26/Aug/2014 H.MAKI		外寸図
SCALE	1/4	MASS	3.2 ±10% kg
DWG. No.	C2040-G01-C	REF. No.	02-170-100G-4
			NAME NETWORK FISH FINDER
			OUTLINE DRAWING



# FURUNO Worldwide Warranty for Pleasure Boats (Except North America)

This warranty is valid for products manufactured by Furuno Electric Co. (hereafter FURUNO) and installed on a pleasure boat. Any web based purchases that are imported into other countries by anyone other than a FURUNO certified dealer may not comply with local standards. FURUNO strongly recommends against importing these products from international websites as the imported product may not work correctly and may interfere with other electronic devices. The imported product may also be in breach of the local laws and mandated technical requirements. Products imported into other countries as described previously shall not be eligible for local warranty service.

For products purchased outside of your country please contact the national distributor of Furuno products in the country where purchased.

This warranty is in addition to the customer's statutory legal rights.

## 1. Terms and Conditions of Warranty

FURUNO guarantees that each new FURUNO product is the result of quality materials and workmanship. The warranty is valid for a period of 2 years (24 months) from the date of the invoice, or the date of commissioning of the product by the installing certified dealer.

## 2. FURUNO Standard Warranty

The FURUNO standard warranty covers spare parts and labour costs associated with a warranty claim, provided that the product is returned to a FURUNO national distributor by prepaid carrier.

The FURUNO standard warranty includes:

- Repair at a FURUNO national distributor
- All spare parts for the repair
- Cost for economical shipment to customer

## 3. FURUNO Onboard Warranty

If the product was installed/commissioned and registered by a certified FURUNO dealer, the customer has the right to the onboard warranty.

The FURUNO onboard warranty includes

- Free shipping of the necessary parts
- Labour: Normal working hours only
- Travel time: Up to a maximum of two (2) hours
- Travel distance: Up to a maximum of one hundred and sixty (160) KM by car for the complete journey

## 4. Warranty Registration

For the Standard Warranty - presentation of product with serial number (8 digits serial number, 1234-5678) is sufficient. Otherwise, the invoice with serial number, name and stamp of the dealer and date of purchase is shown.

For the Onboard Warranty your FURUNO certified dealer will take care of all registrations.

## 5. Warranty Claims

For the Standard Warranty - simply send the defective product together with the invoice to a FURUNO national distributor. For the Onboard Warranty – contact a FURUNO national distributor or a certified dealer. Give the product's serial number and describe the problem as accurately as possible.

Warranty repairs carried out by companies/persons other than a FURUNO national distributor or a certified dealer is not covered by this warranty.

## 6. Warranty Limitations

When a claim is made, FURUNO has a right to choose whether to repair the product or replace it.

The FURUNO warranty is only valid if the product was correctly installed and used. Therefore, it is necessary for the customer to comply with the instructions in the handbook. Problems which result from not complying with the instruction manual are not covered by the warranty.

FURUNO is not liable for any damage caused to the vessel by using a FURUNO product.

The following are excluded from this warranty:

- a. Second-hand product
- b. Underwater unit such as transducer and hull unit
- c. Routine maintenance, alignment and calibration services.
- d. Replacement of consumable parts such as fuses, lamps, recording papers, drive belts, cables, protective covers and batteries.
- e. Magnetron and MIC with more than 1000 transmitting hours or older than 12 months, whichever comes first.
- f. Costs associated with the replacement of a transducer (e.g. Crane, docking or diver etc.).
- g. Sea trial, test and evaluation or other demonstrations.
- h. Products repaired or altered by anyone other than the FURUNO national distributor or an authorized dealer.
- i. Products on which the serial number is altered, defaced or removed.
- j. Problems resulting from an accident, negligence, misuse, improper installation, vandalism or water penetration.
- k. Damage resulting from a force majeure or other natural catastrophe or calamity.
- l. Damage from shipping or transit.
- m. Software updates, except when deemed necessary and warrantable by FURUNO.
- n. Overtime, extra labour outside of normal hours such as weekend/holiday, and travel costs above the 160 KM allowance
- o. Operator familiarization and orientation.

FURUNO Electric Company, March 1, 2011

## FURUNO Warranty for North America

FURUNO U.S.A., Limited Warranty provides a twenty-four (24) months LABOR and twenty-four (24) months PARTS warranty on products from the date of installation or purchase by the original owner. Products or components that are represented as being waterproof are guaranteed to be waterproof only for, and within the limits, of the warranty period stated above. The warranty start date may not exceed eighteen (18) months from the original date of purchase by dealer from Furuno USA and applies to new equipment installed and operated in accordance with Furuno USA's published instructions.

Magnetrons and Microwave devices will be warranted for a period of 12 months from date of original equipment installation.

Furuno U.S.A., Inc. warrants each new product to be of sound material and workmanship and through its authorized dealer will exchange any parts proven to be defective in material or workmanship under normal use at no charge for a period of 24 months from the date of installation or purchase.

Furuno U.S.A., Inc., through an authorized Furuno dealer will provide labor at no cost to replace defective parts, exclusive of routine maintenance or normal adjustments, for a period of 24 months from installation date provided the work is done by Furuno U.S.A., Inc. or an AUTHORIZED Furuno dealer during normal shop hours and within a radius of 50 miles of the shop location.

A suitable proof of purchase showing date of purchase, or installation certification must be available to Furuno U.S.A., Inc., or its authorized dealer at the time of request for warranty service.

This warranty is valid for installation of products manufactured by Furuno Electric Co. (hereafter FURUNO). Any purchases from brick and mortar or web-based resellers that are imported into other countries by anyone other than a FURUNO certified dealer, agent or subsidiary may not comply with local standards. FURUNO strongly recommends against importing these products from international websites or other resellers, as the imported product may not work correctly and may interfere with other electronic devices. The imported product may also be in breach of the local laws and mandated technical requirements. Products imported into other countries, as described previously, shall not be eligible for local warranty service.

For products purchased outside of your country please contact the national distributor of Furuno products in the country where purchased.

### WARRANTY REGISTRATION AND INFORMATION

To register your product for warranty, as well as see the complete warranty guidelines and limitations, please visit [www.furunousa.com](http://www.furunousa.com) and click on "Support". In order to expedite repairs, warranty service on Furuno equipment is provided through its authorized dealer network. If this is not possible or practical, please contact Furuno U.S.A., Inc. to arrange warranty service.

FURUNO U.S.A., INC.  
**Attention: Service Coordinator**  
4400 N.W. Pacific Rim Boulevard  
Camas, WA 98607-9408  
Telephone: (360) 834-9300  
FAX: (360) 834-9400

Furuno U.S.A., Inc. is proud to supply you with the highest quality in Marine Electronics. We know you had several choices when making your selection of equipment, and from everyone at Furuno we thank you. Furuno takes great pride in customer service.



## Declaration of Conformity



We **FURUNO ELECTRIC CO., LTD.**

(Manufacturer)

9-52 Ashihara-Cho, Nishinomiya City, 662-8580, Hyogo, Japan

(Address)

declare under our sole responsibility that the product

**NETWORK FISH FINDER DFF1-UHD**

(Model name, type number)

to which this declaration relates conforms to the following standard(s) or other normative document(s)

**EU**  
EMC Directive 2014/30/EU

**UK**  
SI 2016 No.1091 EMC Regulations 2016 as amended

IEC 60945 Ed.4.0: 2002

EN 60945: 2002

For assessment, see

- Test report  
Furuno Labotech International Co., Ltd.  
FLI 12-12-121, 19 Jan 2013

For assessment, see

- Test report  
Furuno Labotech International Co., Ltd.  
FLI 12-12-121, 19 Jan 2013

(title and/or number and date of issue of the standard(s) or other normative document(s))

On behalf of Furuno Electric Co., Ltd.

Nishinomiya City, Japan  
26 July 2021

(Place and date of issue)

Akihiko Kanechika  
Department General Manager  
Quality Assurance Department

(name and signature or equivalent marking of authorized person)

## PSTI Statement of Compliance

We **FURUNO ELECTRIC CO., LTD.**

(Name of manufacturer of the product)

9-52 Ashihara-Cho, Nishinomiya City, 662-8580, Hyogo, Japan

(Address of manufacturer of the product)

declare under our sole responsibility that the product

**NETWORK FISH FINDER,  
DFF1-UHD**

(Product type, batch)

**October / 31 / 2028**

(Support period for the product)

[https://www.furuno.co.jp/en/csr/sociality/customer/product\\_security.html](https://www.furuno.co.jp/en/csr/sociality/customer/product_security.html)

(Weblink for latest information and contact to report to the manufacturer security issues)

to which this declaration relates conforms to the following standard(s) or other normative document(s)

Product Security and Telecommunications Infrastructure Act 2022

Product Security and Telecommunications Infrastructure (Security Requirements for  
Relevant Connectable Products) Regulations 2023 Schedule 1

On behalf of Furuno Electric Co., Ltd.

Nishinomiya City, Japan  
27 October 2025

(Place and date of issue)

Akihiko Kanechika  
Department General Manager  
Quality Assurance Department

(Signature, name and function of the signatory)





**FURUNO ELECTRIC CO., LTD.**

9-52, Ashihara-cho,  
Nishinomiya, 662-8580, JAPAN

·FURUNO Authorized Distributor/Dealer

All rights reserved. Printed in Japan

A: JAN. 2013  
K: DEC. 15, 2025

Pub. No. OME-20400-K  
(REFU) DFF1-UHD



00010116920